

Boosting Event Generation with Generative Networks

ASC school 2022: Physics meets Artificial Intelligence

Theo Heimel, ITP Heidelberg



A short overview on LHC physics

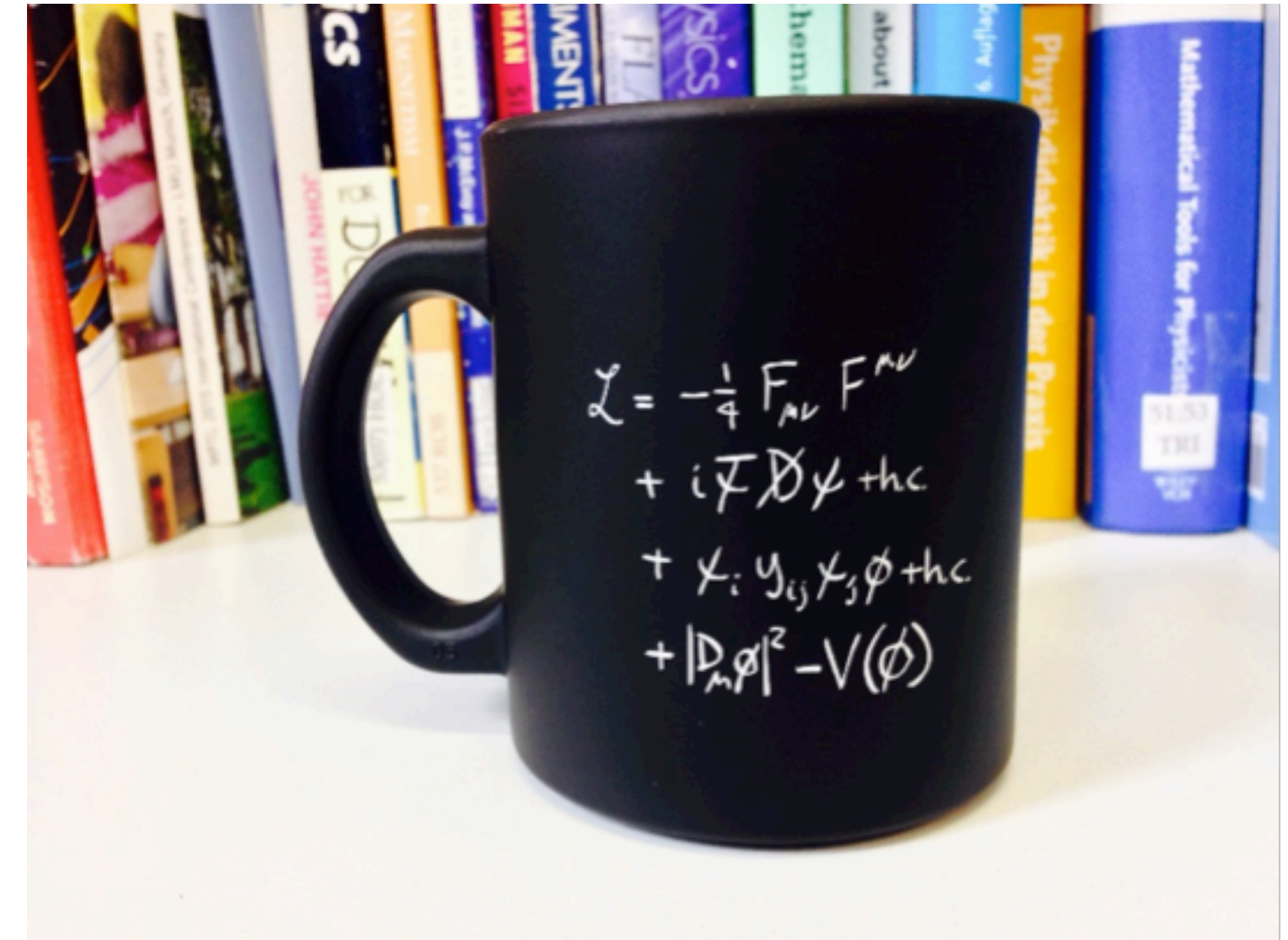
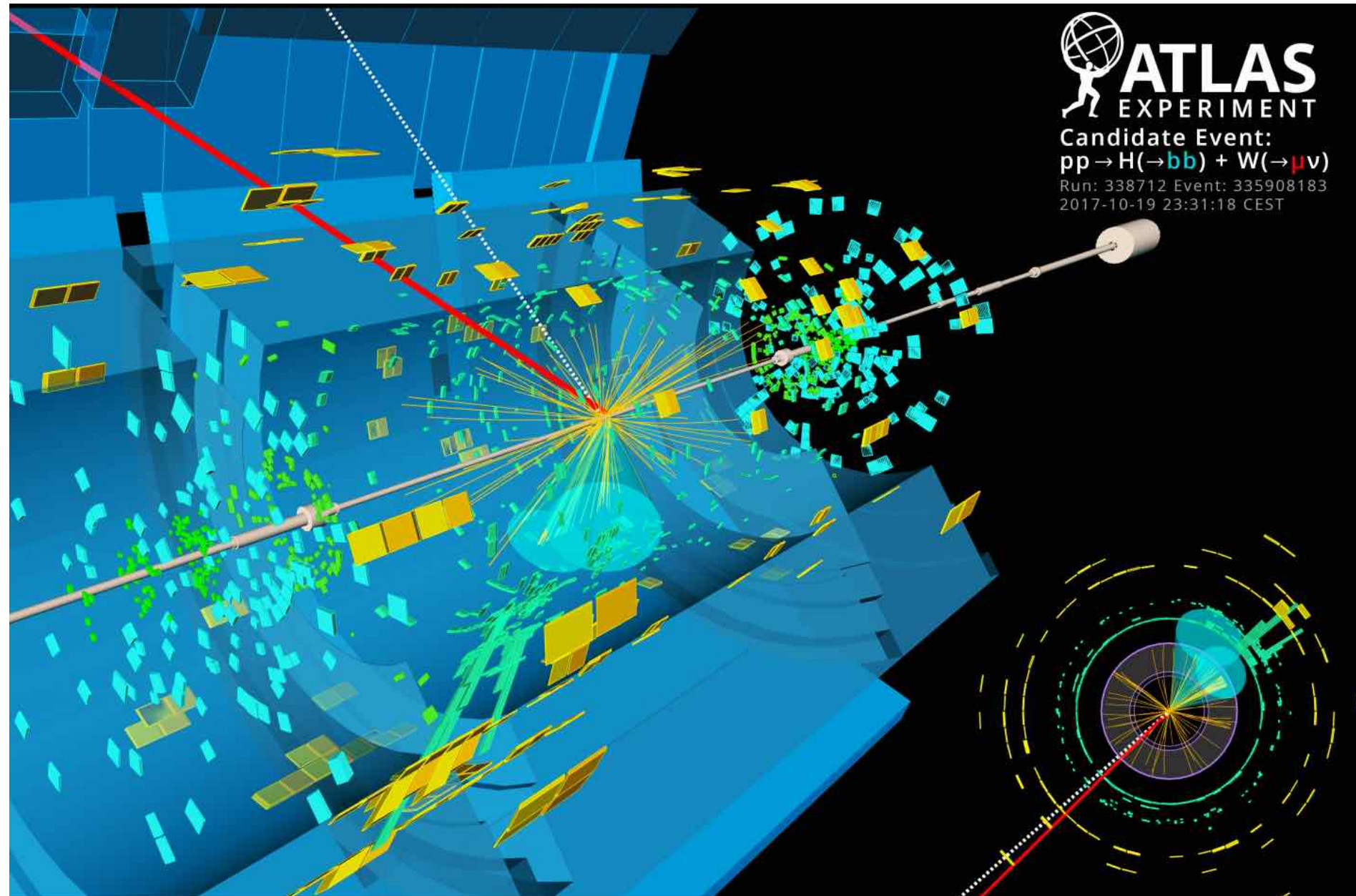

Setting

- Large Hadron Collider at CERN
- Proton collisions at 13 TeV
- **Huge** dataset $\sim 1\text{Pb/s}$ before trigger selection

Goal

- Understand full dataset from **1st principles**
- Find signs of new physics (1 in 10^{10} or less)
- and it looks exactly like the background

ML for big data in particle physics

Top tagging

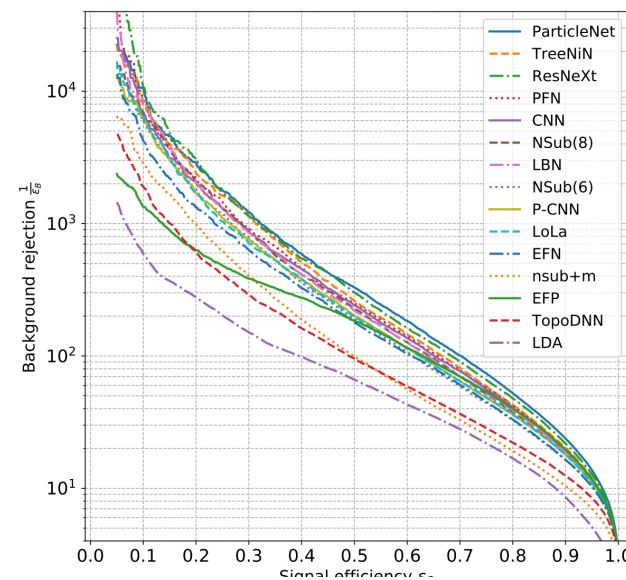

G. Kasieczka et al. [1902.09914]

Anomaly detection

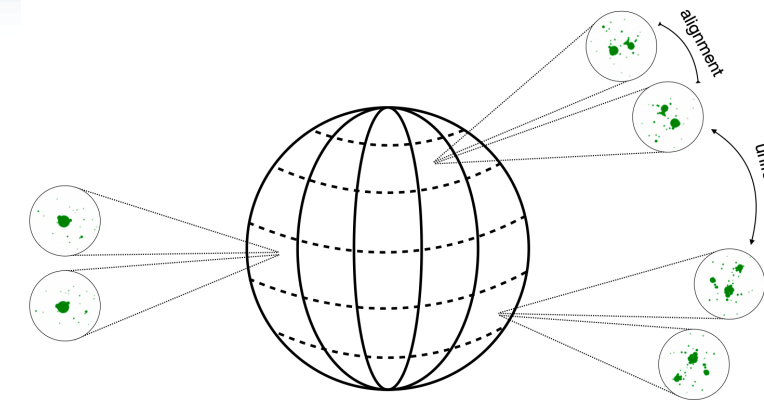

B. Dillon et al. [2108.04253]

Event generation

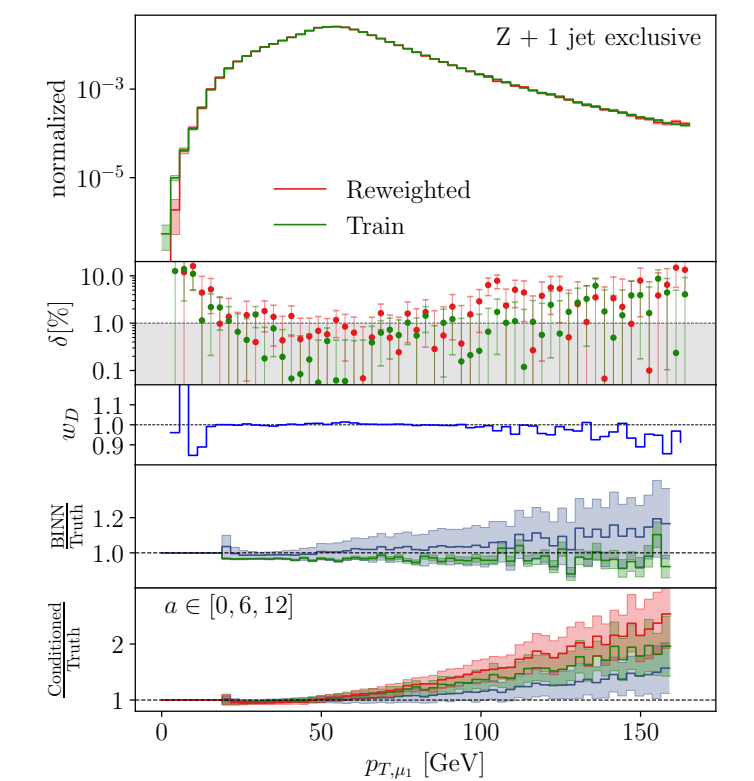

A. Butter et al. [2110.13632]

Track reconstruction

Kaggle challenge

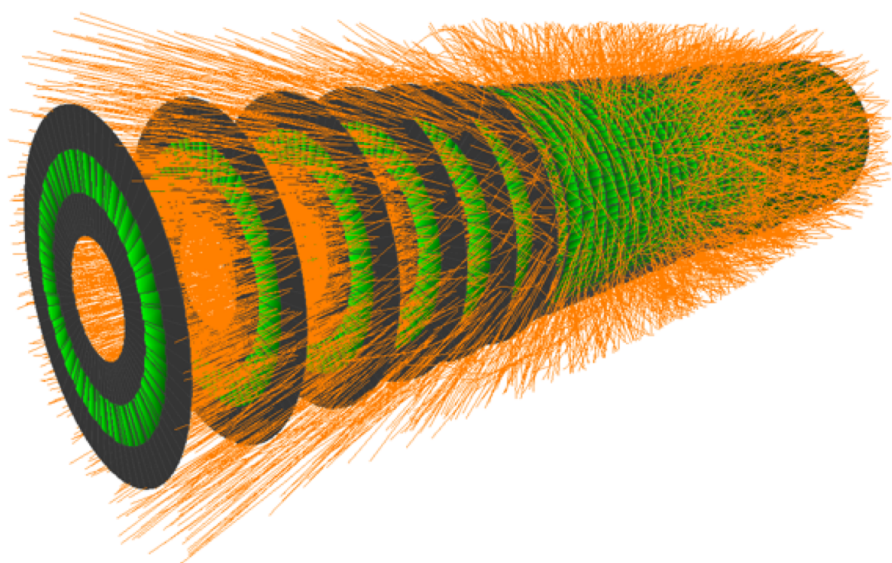

Amplitude estimation

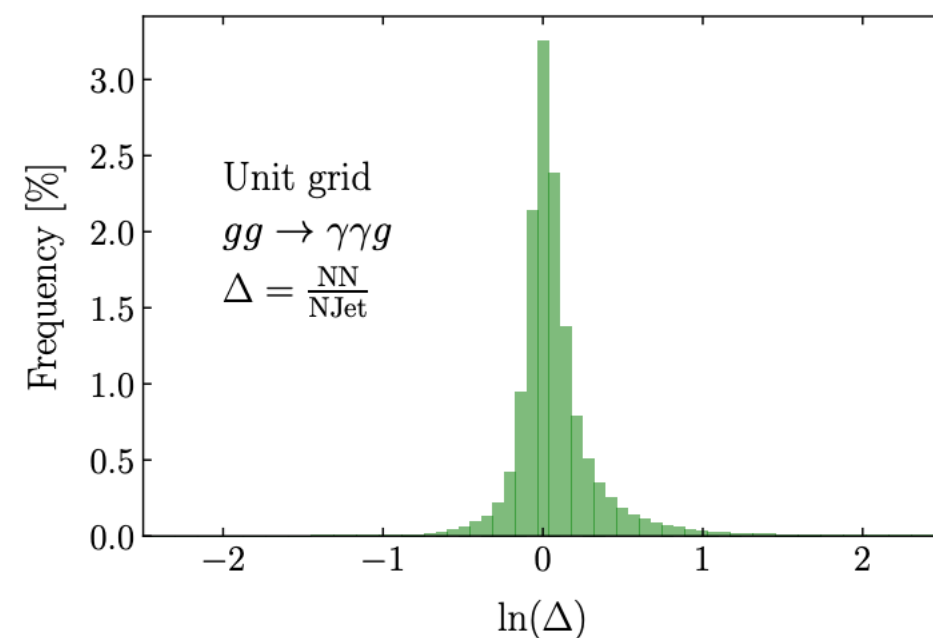

J. Aylett-Bullock, et al. [2106.09474]

Classification

Generative models

Graph networks

Bayesian networks

Regression

Detector simulation

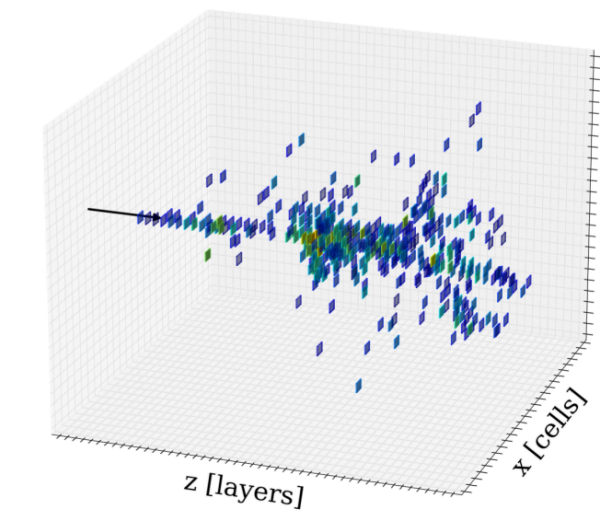

E. Buhmann et al. [2112.09709]

Jet calibration & uncertainties

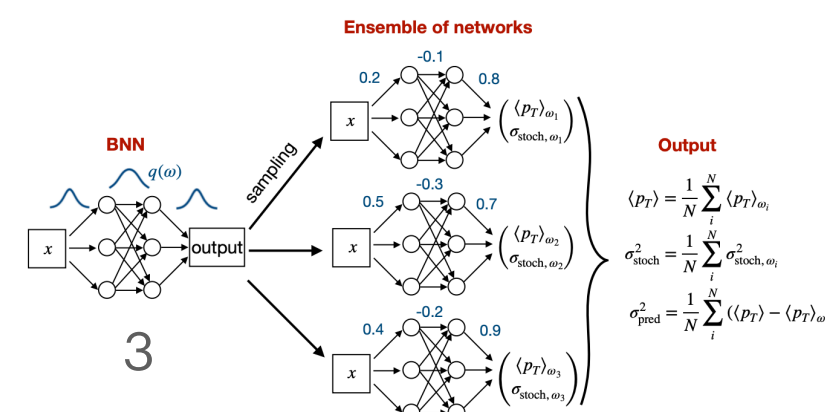

G. Kasieczka et al. [2003.11099]

Complete citations $\mathcal{O}(800)$
<https://iml-wg.github.io/HEPML-LivingReview/>

Open questions towards HL-LHC

A biased selection

- Facing **25 times** the amount of data
- What do we need to understand the data? (*read*: find new physics)

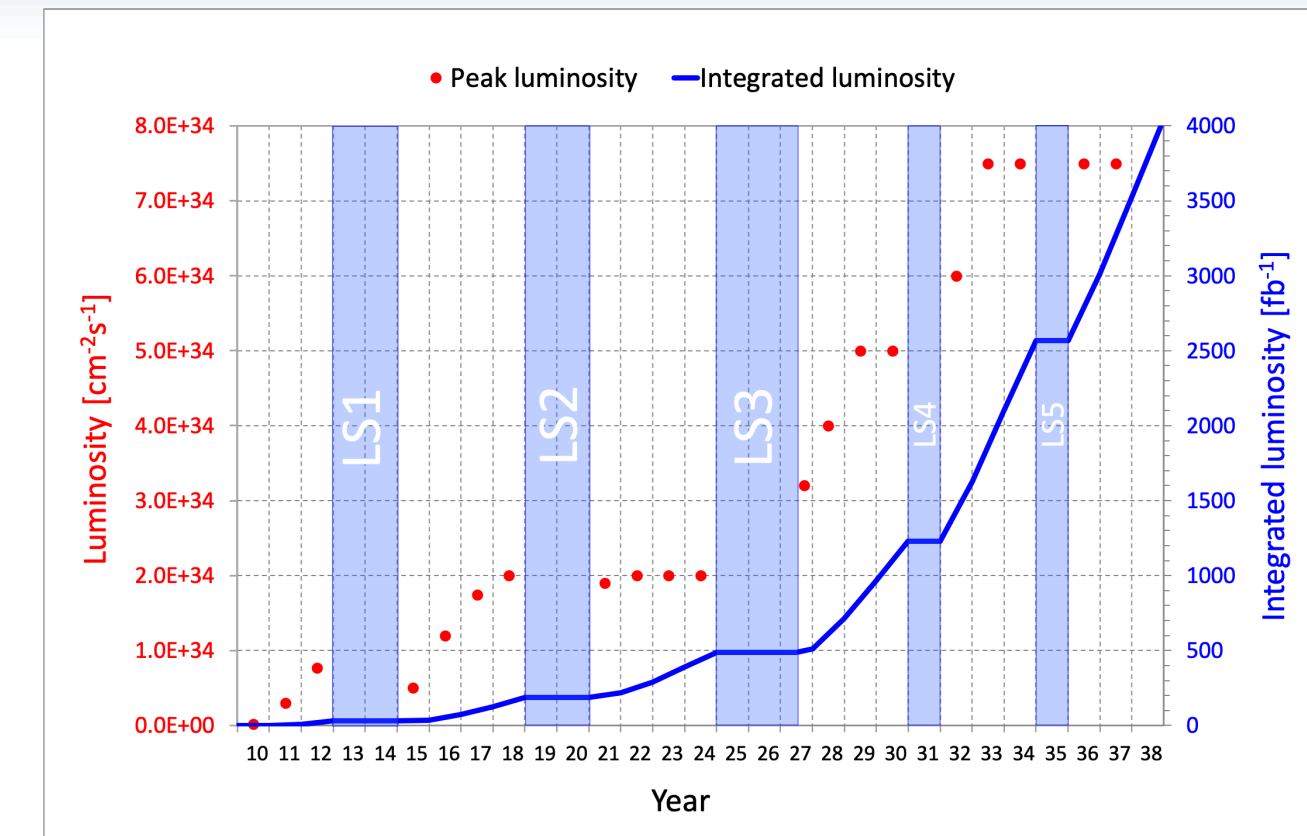

• Precision predictions

- Higher order calculations
- Event generation
- Detector simulation

• Optimized analysis for high-dimensional data

- Likelihood free inference
 - Unfolding = Inverse problem
- How to get most out of data

Problems beyond supervised classification/regression → How can machine learning help?

How to generate LHC events

Event generation at the LHC

A theorist's perspective

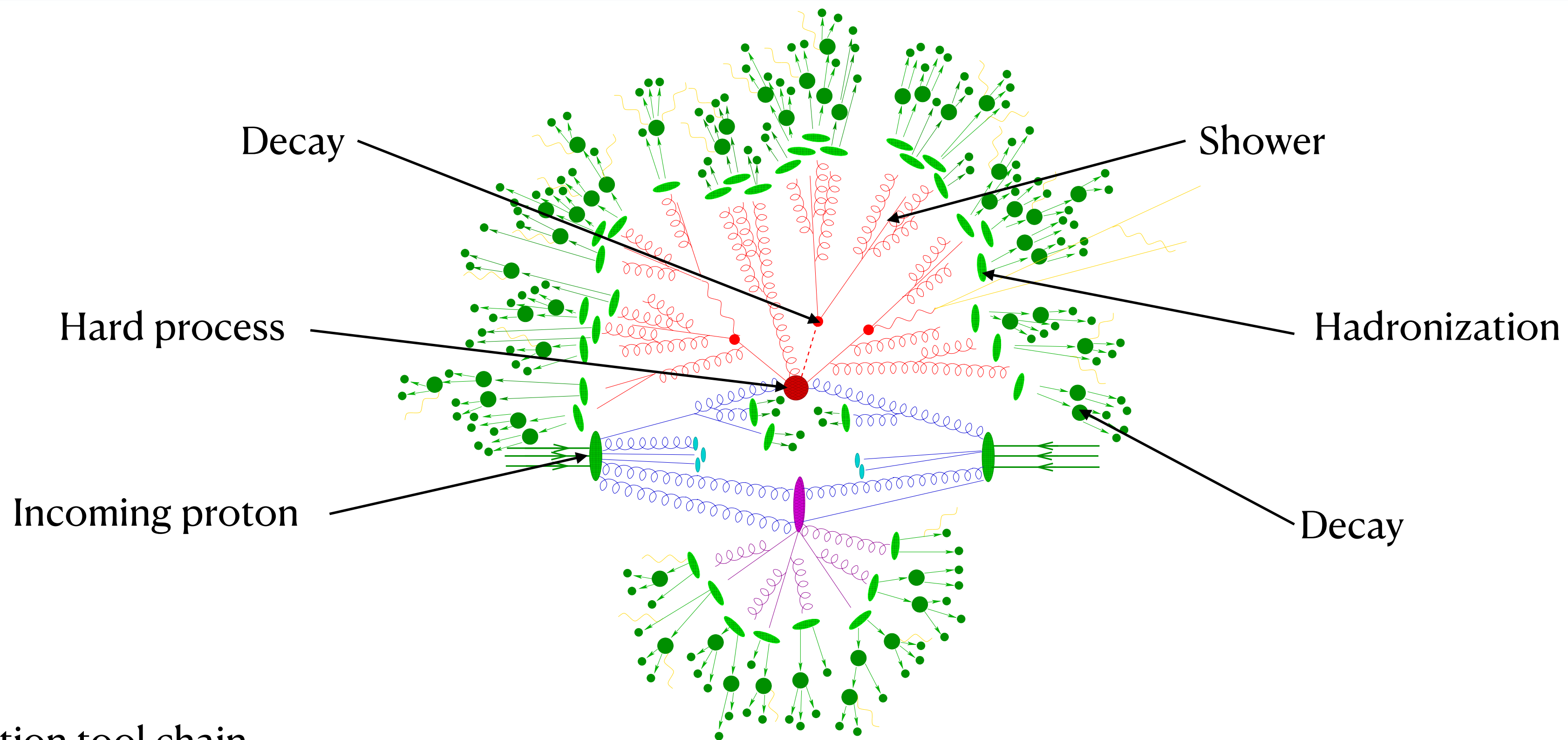

Every line is a particle!

4-vector representation

$$(E, p_x, p_y, p_z)$$

$$\text{with } E^2 = m^2 + \vec{p}^2$$

Simulation tool chain

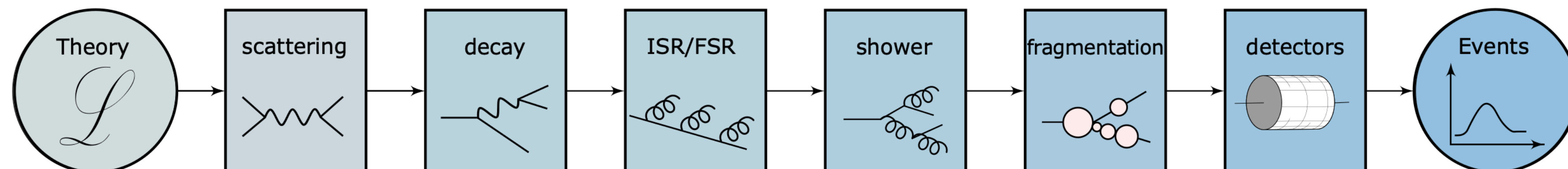

Monte Carlo event generation

1. Generate phase space points

→ set of four-momenta p_i

2. Calculate event weight

$$w_{\text{event}} = f(x_1, Q^2) f(x_2, Q^2) \times \mathcal{M}(x_1, x_2, p_1, \dots, p_n) \times J(p_i(r))$$

Parton density function

Matrix element †

Phase space mapping

3. Unweighting †

keep events with $\frac{w_i}{w_{\text{max}}} > r \in [0,1]$

† Bottlenecks

1. Slow **matrix element** calculation
 - ◆ Complexity grows exponentially with
 - # final state particles
 - Precision (LO, NLO, NNLO, ...)
2. Low **unweighting** efficiency
 - ◆ Discard most events if $w_i \ll w_{\text{max}}$
 - ◆ Optimize phase space mapping
 - ➔ $J(p_i(r)) = (f \times \mathcal{M})^{-1}$

Approximating Amplitudes

- Approximate Amplitude $\mathcal{M}(x_1, x_2, p_1, \dots, p_n)$ with NN
- Regression problem with NN
 - + Generalization of interpolation
 - + Better scaling than grids for large dimensions
- Minimize distance between prediction and truth
 - $\Rightarrow \mathcal{L} = (NN(p_i) - \mathcal{M}(p_i))^2 / 2\sigma^2 + \mathcal{L}_{BNN}$
- **Twist:** Boosting techniques to improve precision
 - Retrain on bad samples
 - 1% precision
 - Boost for reliable uncertainties or small deviations

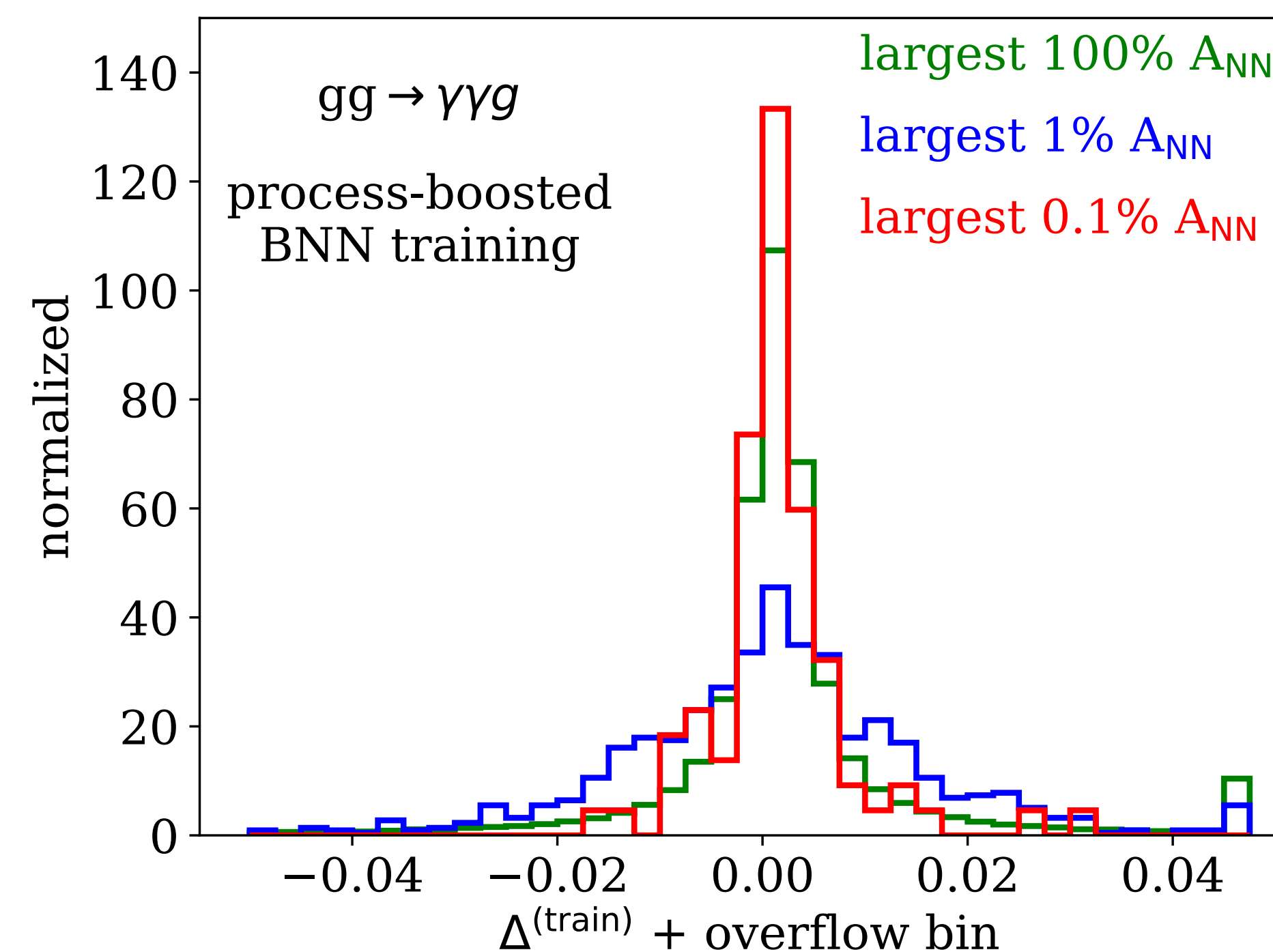

Monte Carlo event generation

1. Generate phase space points

→ set of four-momenta p_i

2. Calculate event weight

$$w_{\text{event}} = f(x_1, Q^2) f(x_2, Q^2) \times \mathcal{M}(x_1, x_2, p_1, \dots, p_n) \times J(p_i(r))$$

Parton density function

Matrix element †

Phase space mapping

3. Unweighting †

keep events with $\frac{w_i}{w_{\text{max}}} > r \in [0,1]$

† Bottlenecks

1. Slow **matrix element** calculation
 - ◆ Complexity grows exponentially with
 - # final state particles
 - Precision (LO, NLO, NNLO, ...)
2. Low **unweighting** efficiency
 - ◆ Discard most events if $w_i \ll w_{\text{max}}$
 - ◆ Optimize phase space mapping
 - ➔ $J(p_i(r)) = (f \times \mathcal{M})^{-1}$

Monte Carlo event generation

1. Generate phase space points

→ set of four-momenta p_i

2. Calculate event weight

$$w_{\text{event}} = f(x_1, Q^2)f(x_2, Q^2) \times \mathcal{M}(x_1, x_2, p_1, \dots, p_n) \times J(p_i(r))$$

Parton density function

Matrix element †

Phase space mapping

3. Unweighting †

keep events with $\frac{w_i}{w_{\text{max}}} > r \in [0,1]$

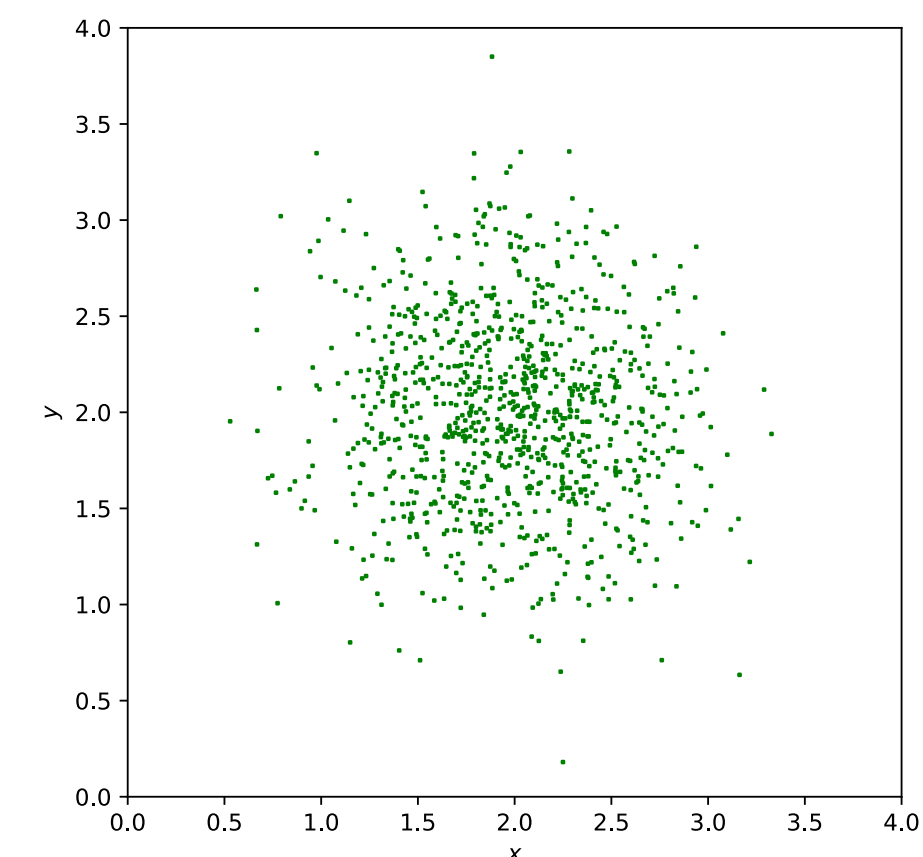
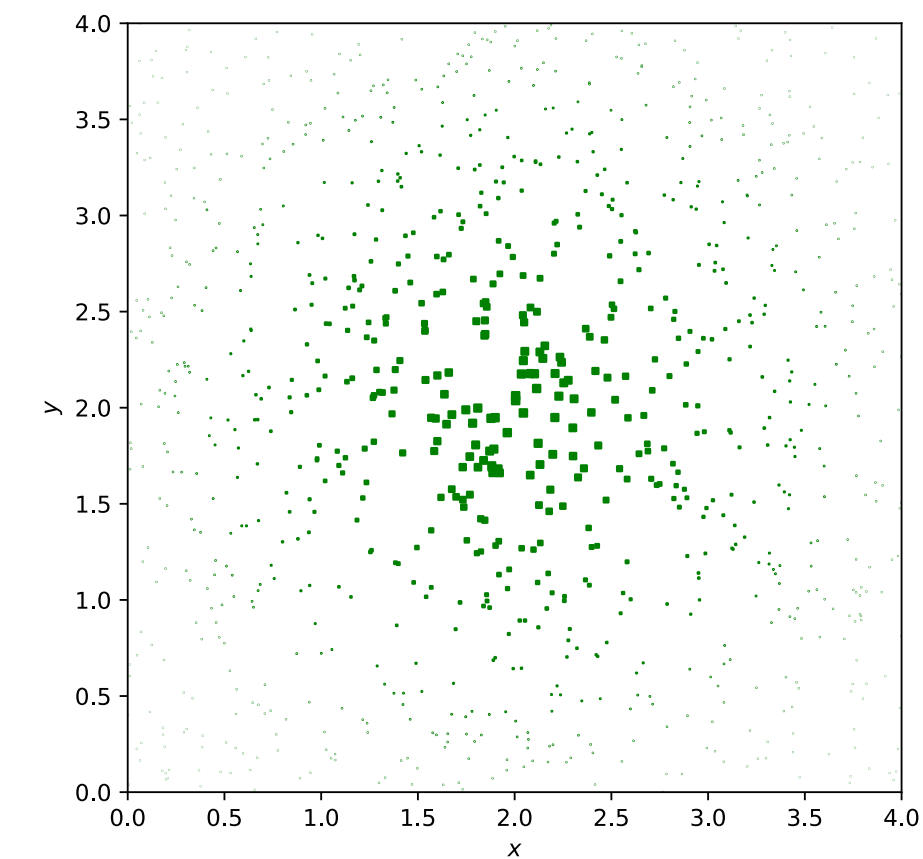

Normalizing flows

Invertible networks for complex transformations

- + Bijective mapping
- + Tractable Jacobian $\rightarrow p_x(x) = p_z(z) \cdot J_{NN}$
- + Fast evaluation in both direction

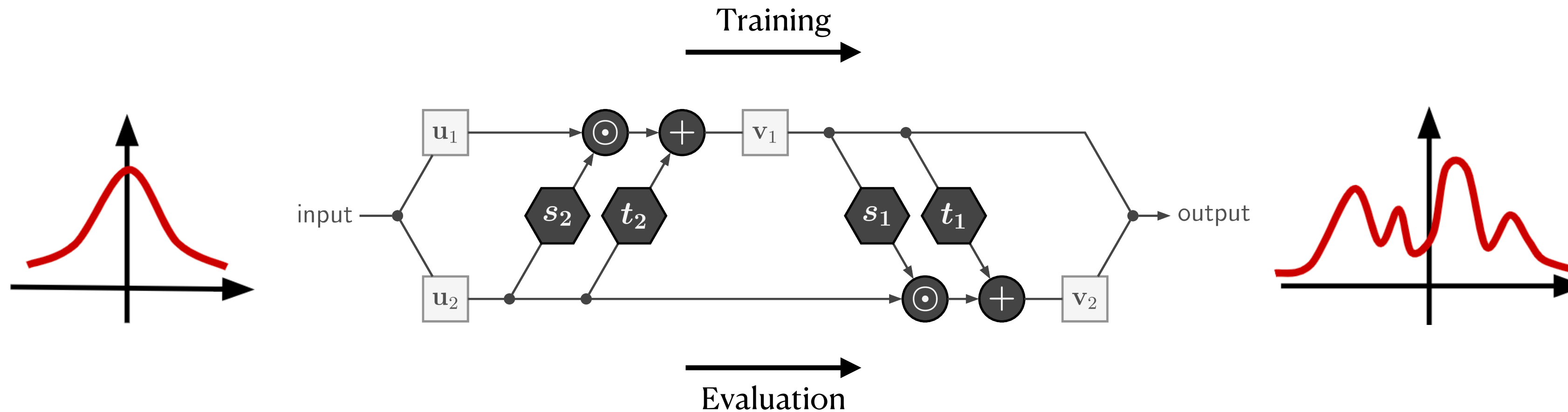

Training on density $t(x)$
 \rightarrow Minimize difference

$$\begin{aligned}\mathcal{L} &= \log p_x(x)/t(x) \\ &= \log p_z(z(x)) J_{NN} / t(x)\end{aligned}$$

Training on samples x
 \rightarrow Maximize the log-likelihood

$$\begin{aligned}\mathcal{L} &= \log p(\theta | x) \\ &= \log p(z | \theta) + \log J_{NN} + p(\theta)\end{aligned}$$

Normalizing flows

Invertible networks for complex transformations

- + Bijective mapping
- + Tractable Jacobian $\rightarrow p_x(x) = p_z(z) \cdot J_{NN}$
- + Fast evaluation in both direction

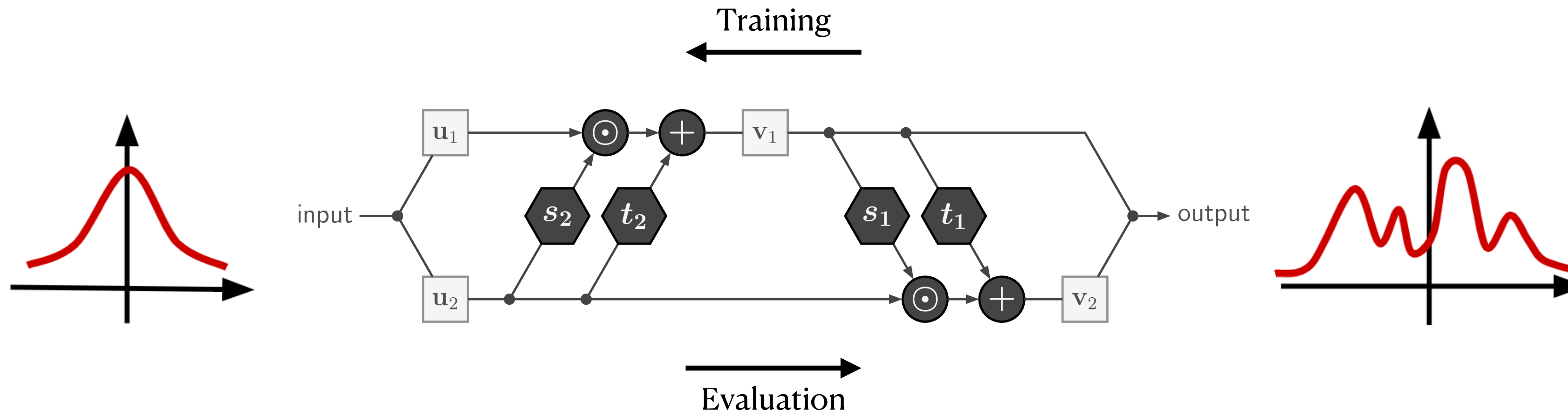

Training on density $t(x)$
 \rightarrow Minimize difference

$$\begin{aligned}\mathcal{L} &= \log p_x(x)/t(x) \\ &= \log p_z(z(x)) J_{NN} / t(x)\end{aligned}$$

Training on samples x
 \rightarrow Maximize the log-likelihood

$$\begin{aligned}\mathcal{L} &= \log p(\theta | x) \\ &= \log p(z | \theta) + \log J_{NN} + p(\theta)\end{aligned}$$

Putting flows to work

Event generation

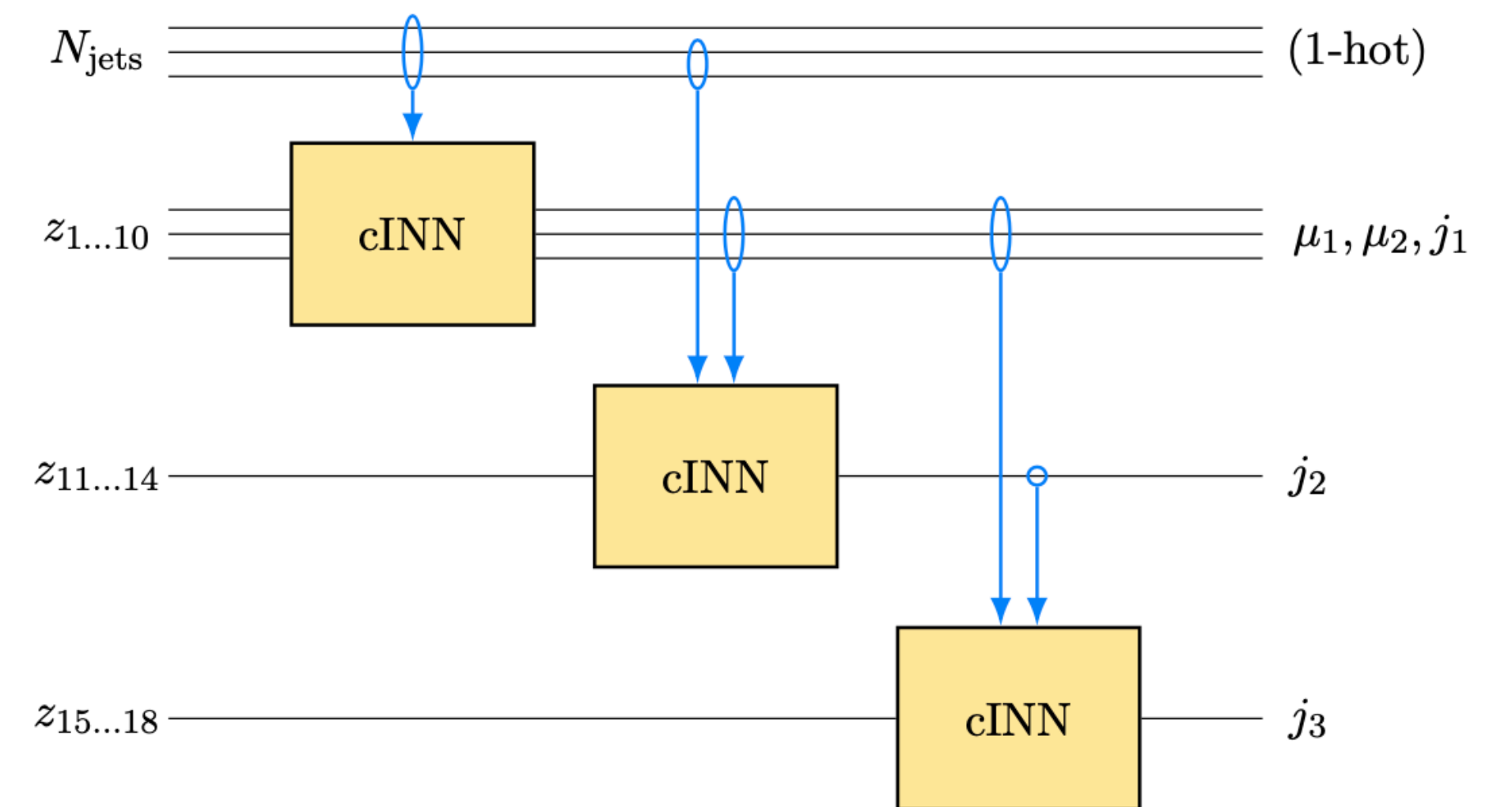
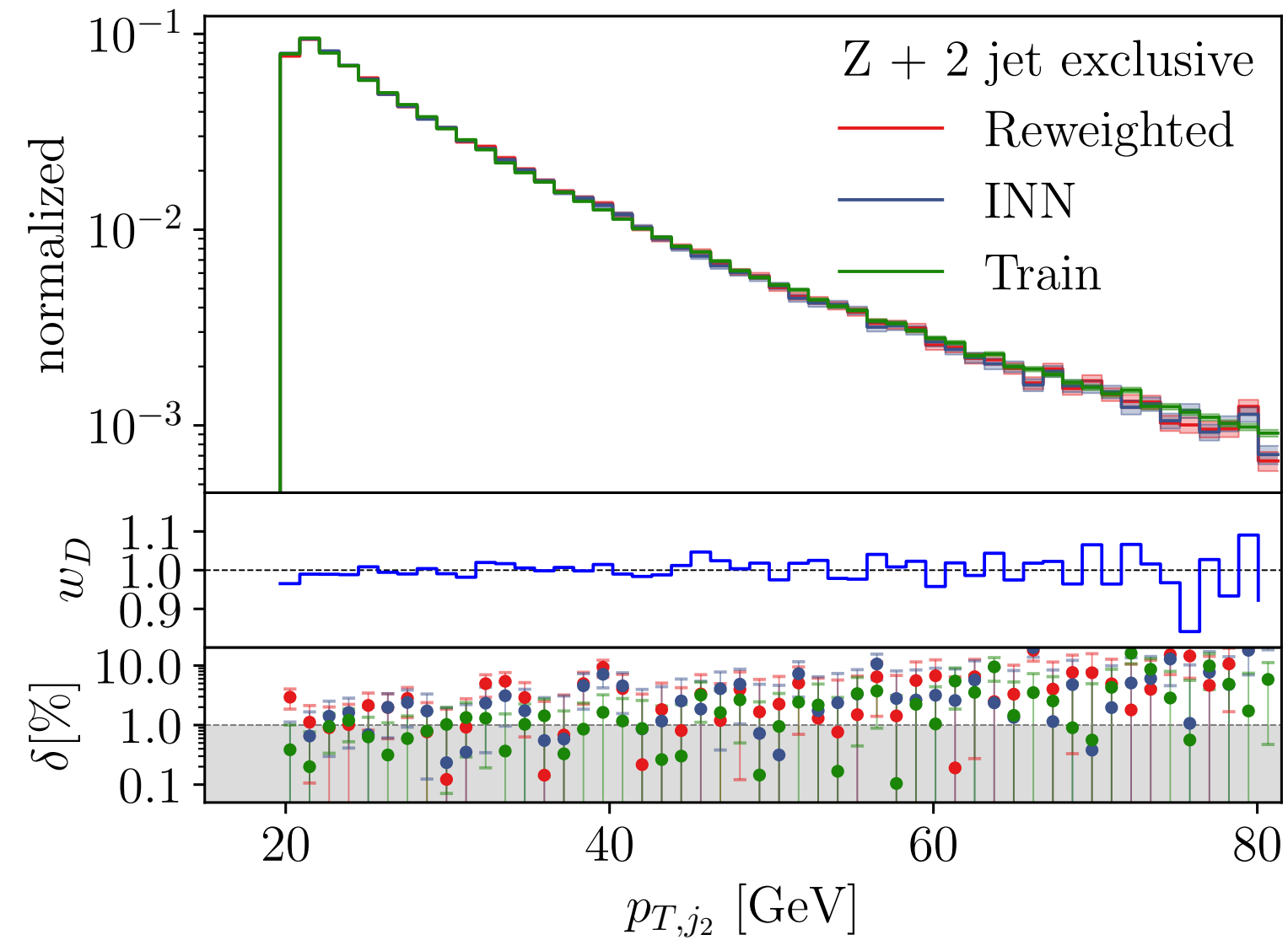

- Train normalizing flow on 4-momenta
- Include symmetries in feature representation
- Excellent performance for direct output
- Extend setup for variable jet multiplicity

Challenges for normalizing flows

- Narrow features
- Topological holes (eg ΔR cuts)
 - no bijective mapping possible
 - can only be approximated

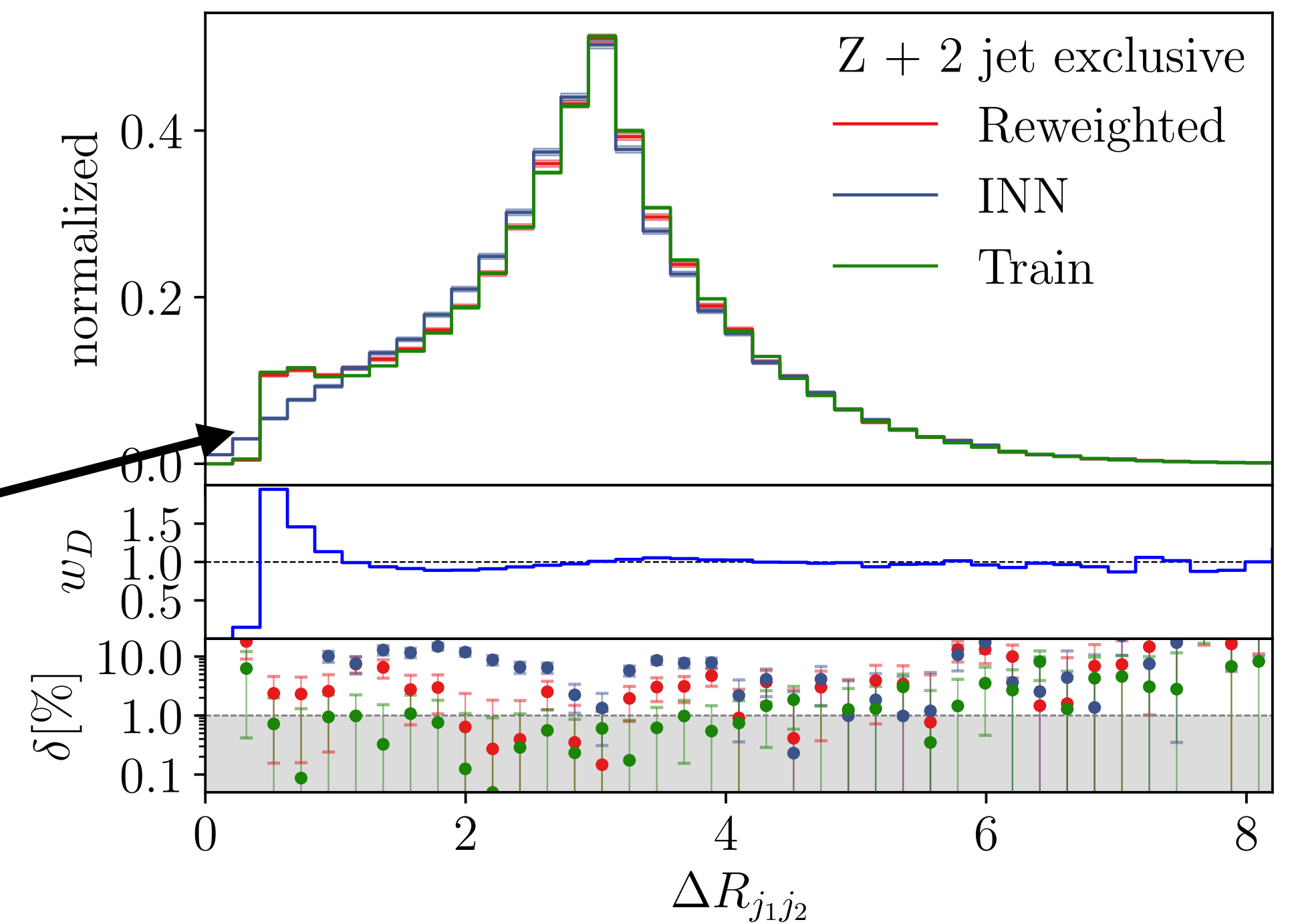
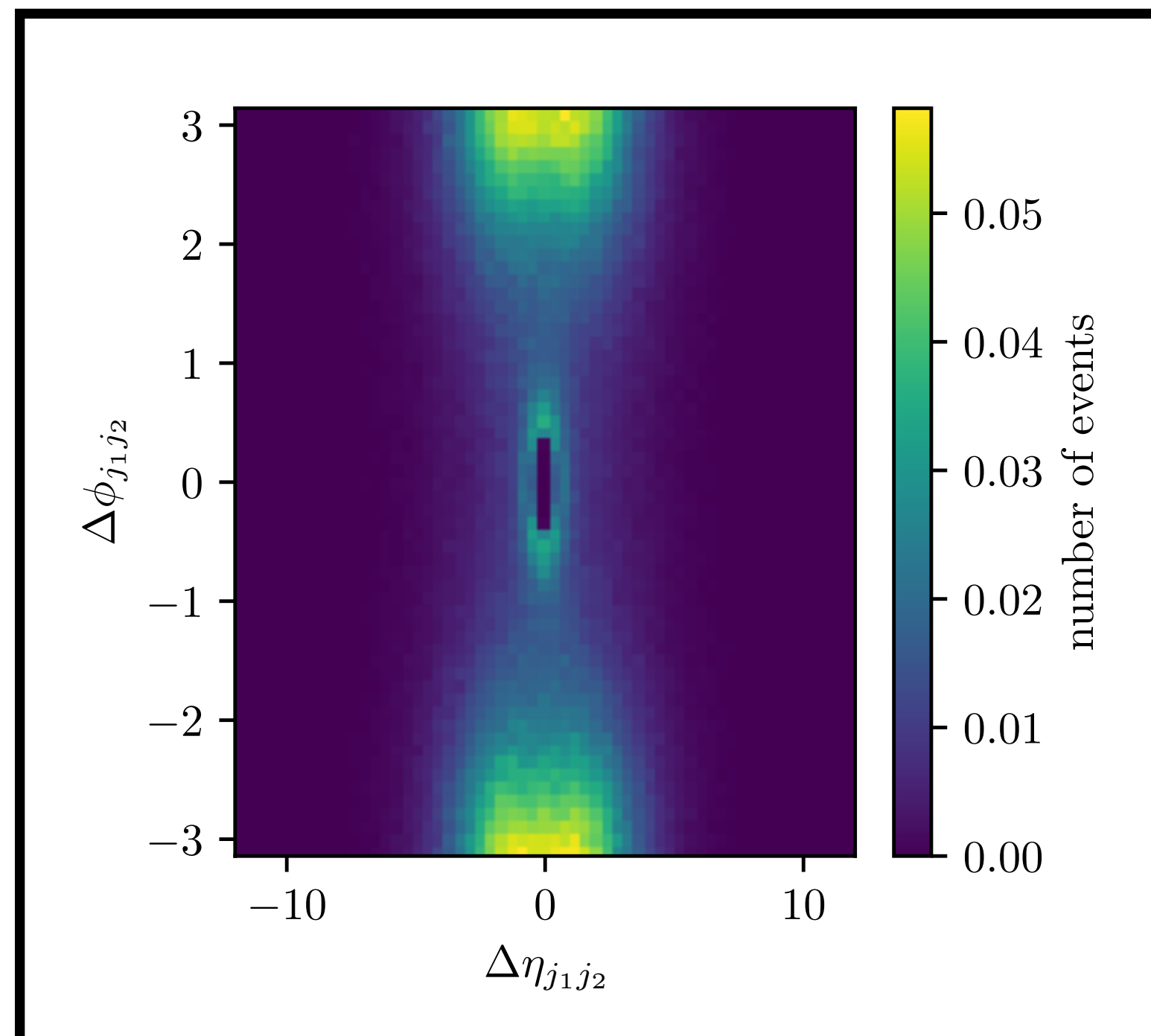

Reweighting for Precision

- Classifier loss

$$\begin{aligned} \mathcal{L} &= - \sum_{x \sim P_{data}} \log(D(x)) - \sum_{x \sim P_{INN}} \log(1 - D(x)) \\ &= - \int dx p_{data}(x) \log(D(x)) + p_{INN}(x) \log(1 - D(x)) \end{aligned}$$

- Upon convergence obtain **reweighting factor**

$$\Rightarrow \frac{p_{data}(x)}{p_{INN}(x)} = \frac{D(x)}{1 - D(x)} = w_D$$

- Use classifier feedback to enhance gradients

$$\mathcal{L}_{DiscFlow} \approx \int dx \underbrace{w_D(x)^\alpha P(x)}_{\text{reweighted truth}} \left(\frac{\psi(x; c)^2}{2} - \log J(x) \right)$$

\Rightarrow Reduces range of reweighting factors

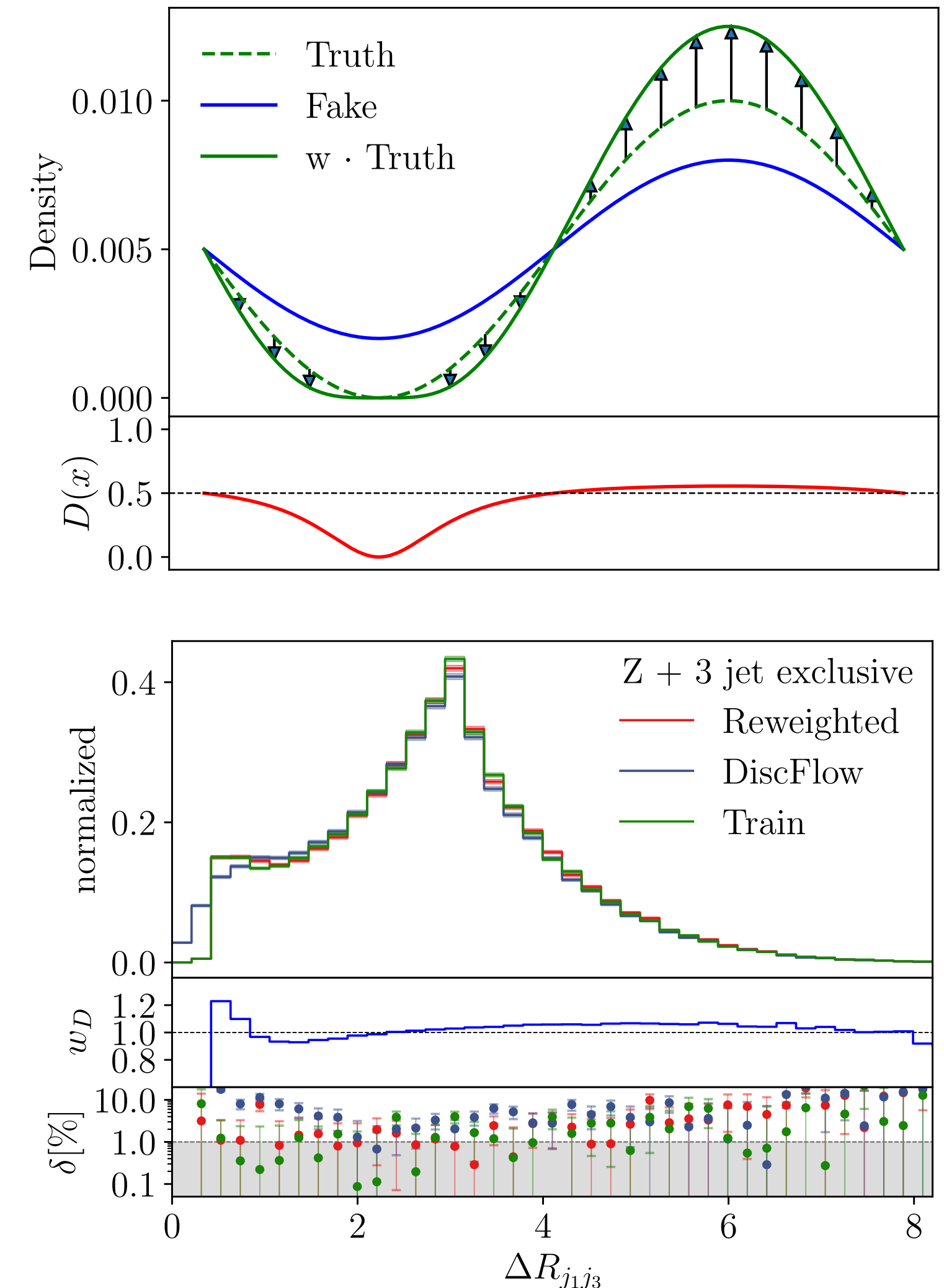

Putting flows to work

Detector simulation

Challenge: large dimensionality ($3 \times 96, 12 \times 12, 12 \times 6$)

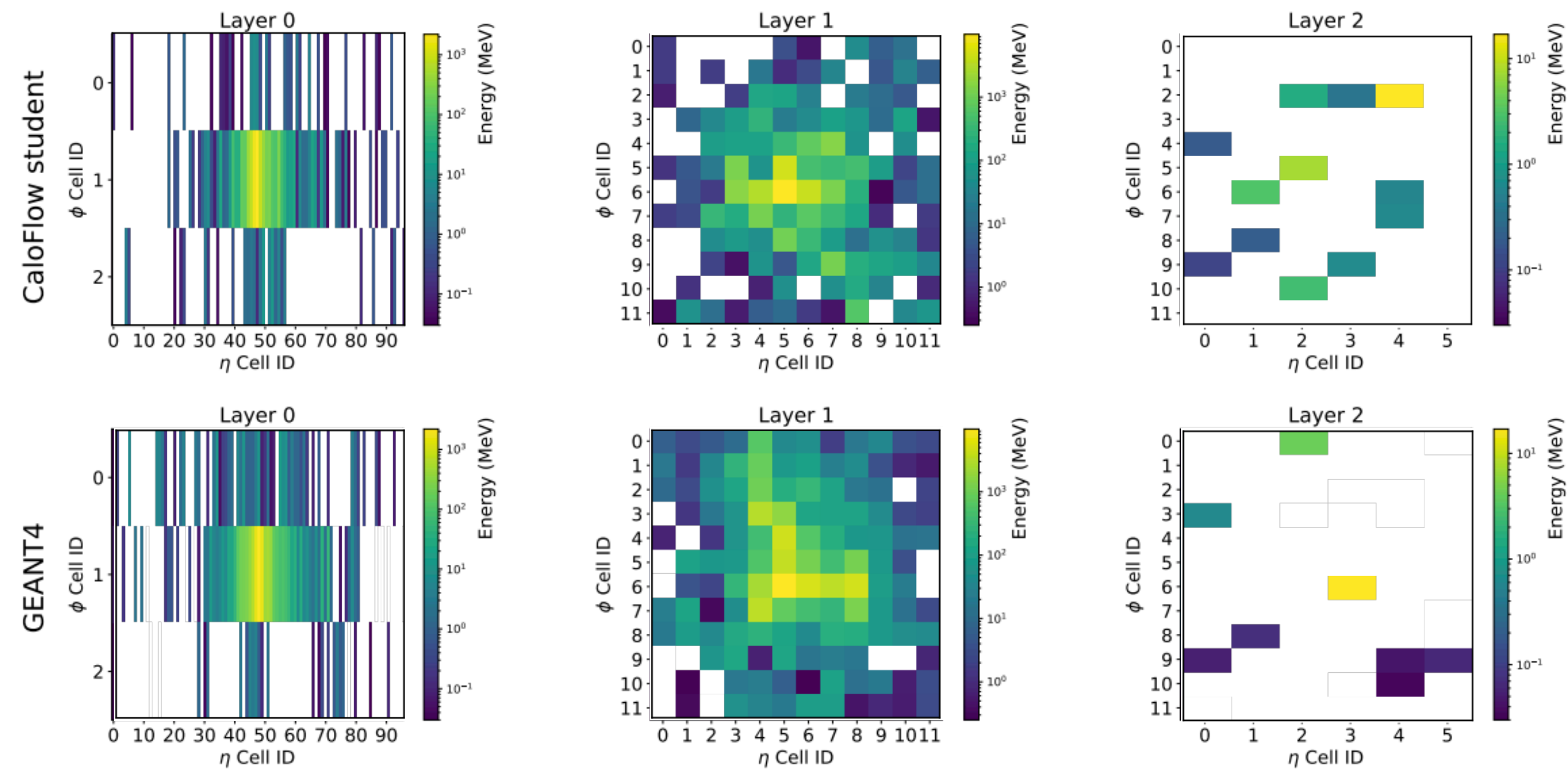

30000 pixels

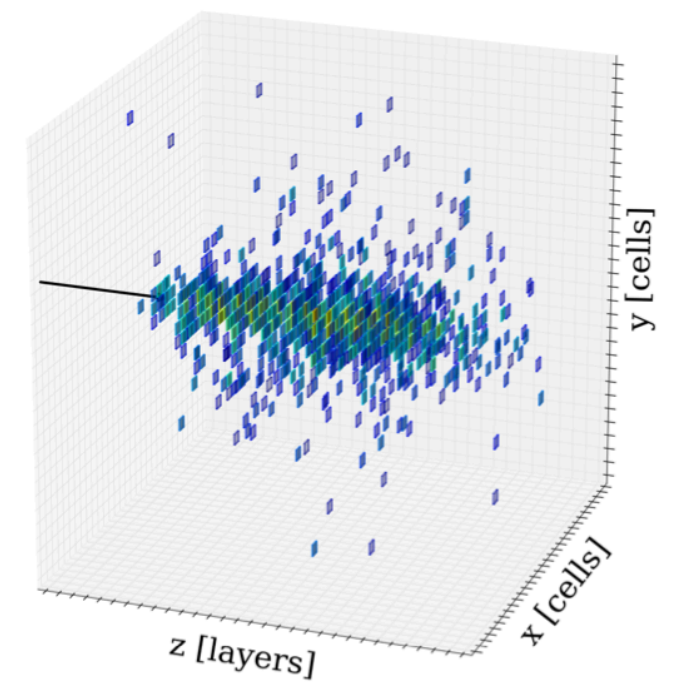

C. Krause & D. Shih [2110.11377]

π^+ shower individual & average

Forward simulations with generative networks

Event generation

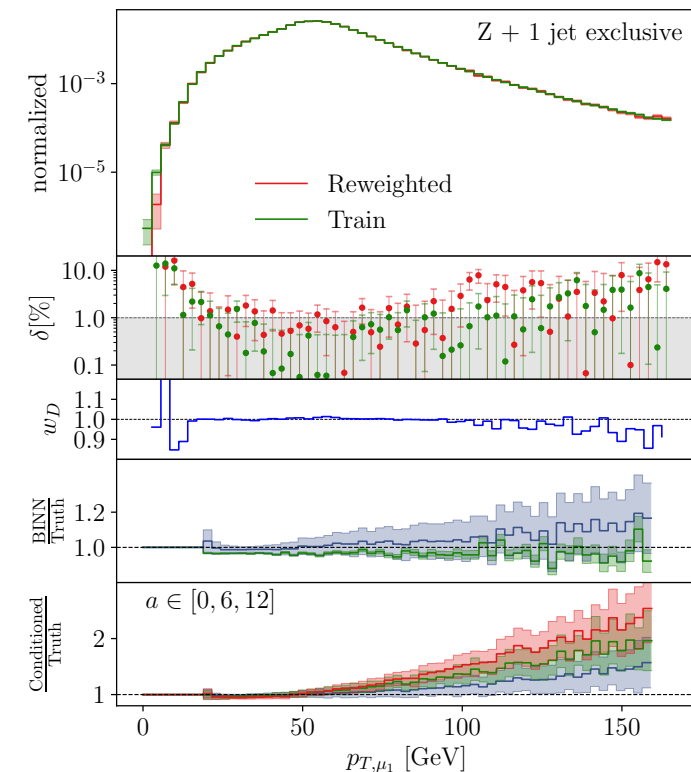

- Otten et al.
- Gao et al.
- Bothmann et al.
- Stienen et al.
- Butter et al.
- and many more

Detector simulation

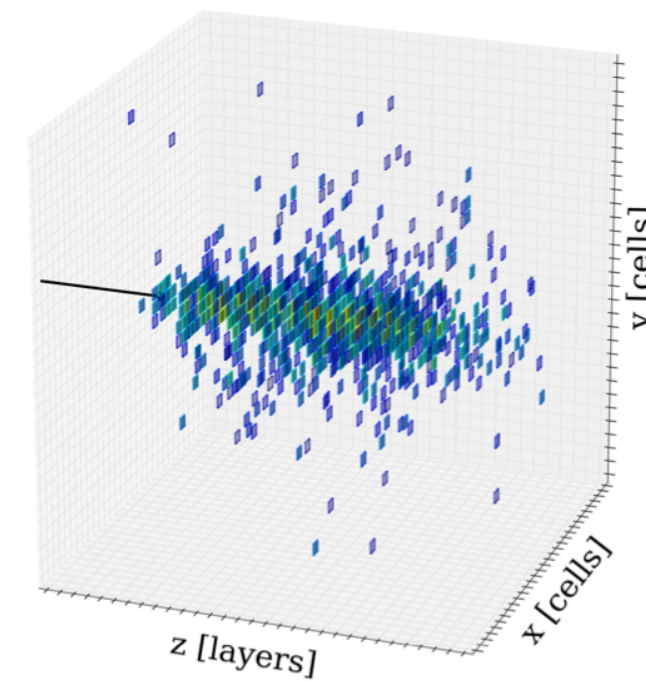

- CaloGAN by M. Paganini et al.
- BIBAE by E. Buhman, S. Diefenbacher et al.
- CaloFlow by C. Krause, D. Shih
- and many more

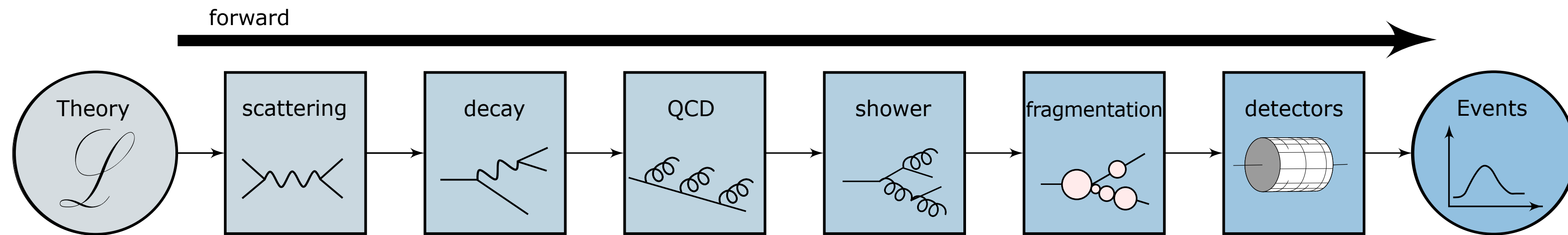

Applications

- Phase space sampling
- End to end learning
- Data compression
- Amplification

Phase space sampling with
generative networks (GAN, VAE, NF)

Particularly promising architecture
→ Normalizing flows

Uncertainties with BINNs & Inverting the Simulation Chain

ASC school 2022: Physics meets Artificial Intelligence

Theo Heimel, ITP Heidelberg



Forward simulations with generative networks

Event generation

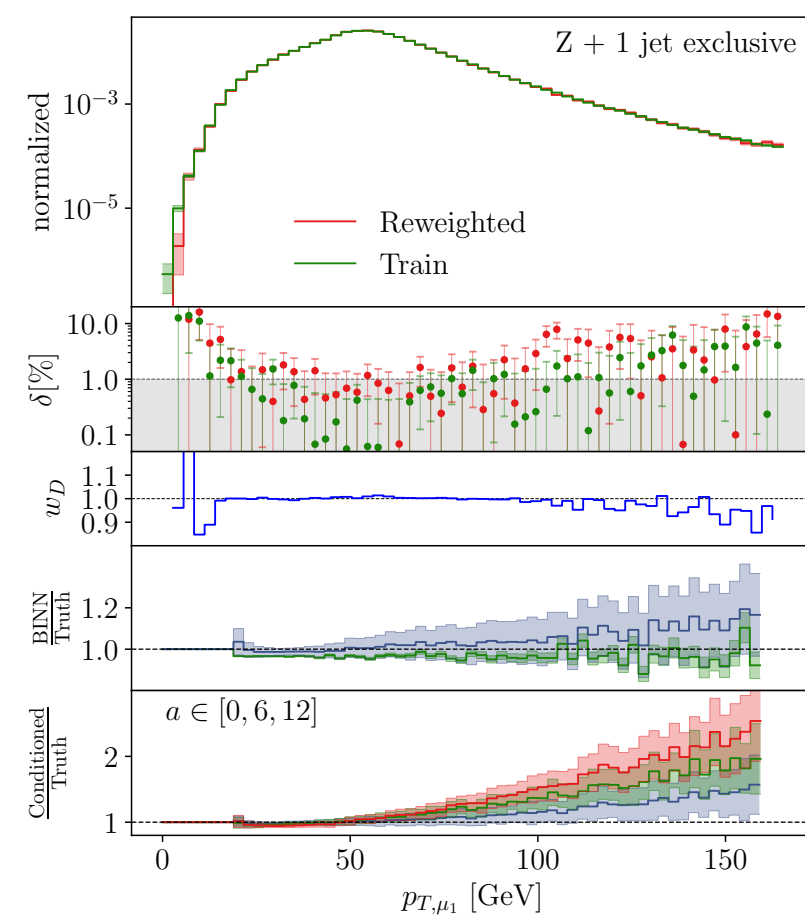

→ Otten et al.

→ Gao et al.

→ Bothmann et al.

→ Stienen et al.

→ AB, et al.

→ and many more

Applications

- Phase space sampling
- End to end learning
- Data compression
- Amplification

What about the uncertainties ???

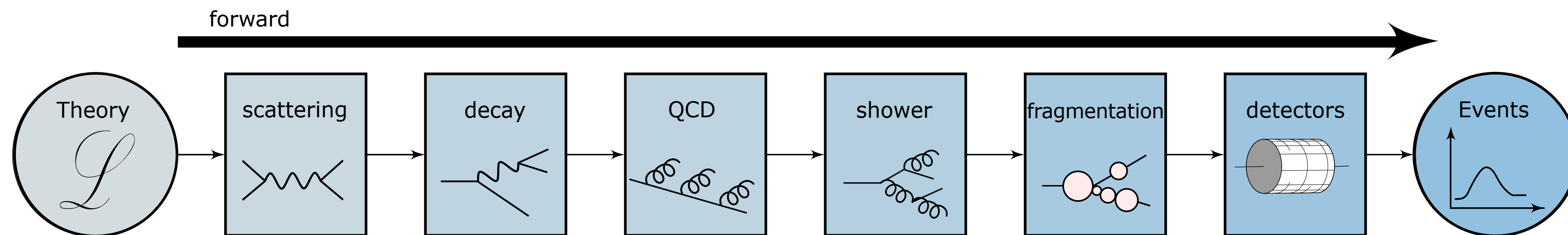

ML Uncertainties

When do we (not) need them?

- Predictions with poorly trained NNs are sub-*optimal* but not *wrong*

- Example 1: **Phase space sampling**

- Mapping induces Jacobian
- Events obtain weight from $ME \times J$
- Bad mapping \rightarrow small unweighting efficiency

- Example 2: INN for **integration**

- Sub-optimal contour deformation
- **High variance** of integral
- Not efficient but not wrong

- Example 3: Data compression
 - Direct use of generator output

- Example 4:
 - Control over network training

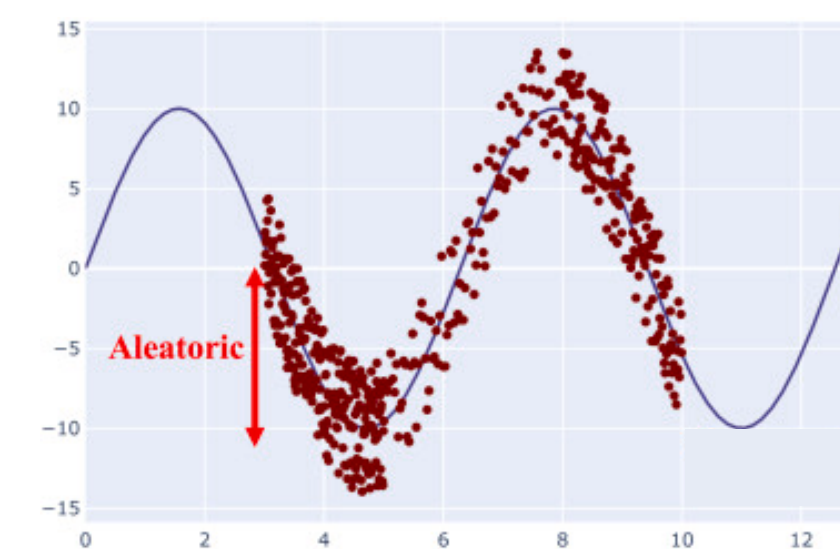

modified from M. Abdar [doi.org/10.1016/j.inffus.2021.05.008]

\rightarrow **Control** comes from **simulation** !

\rightarrow How can we estimate this uncertainty?

Defining the loss function

$$p(A) = \int dw p(A | w)p(w | T) \approx \int dw p(A | w)q(w)$$

Approximate $q(w)$ by minimizing KL divergence

$$\begin{aligned} \mathcal{L}_{BNN} &= \text{KL}[q(w), p(w | T)] \\ &= \int dw q(w) \log \frac{q(w)}{p(w | T)} \\ &= \int dw q(w) \log \frac{q(w)p(T)}{p(w)p(T | w)} \\ &= \text{KL}[q(w), p(w)] - \int dw q(w) \log p(T | w) \end{aligned}$$

Gaussian prior

$$\frac{\sigma_q^2 - \sigma_p^2 + (\mu_q - \mu_p)^2}{2\sigma_p^2} + \log \frac{\sigma_p}{\sigma_q}$$

Standard loss

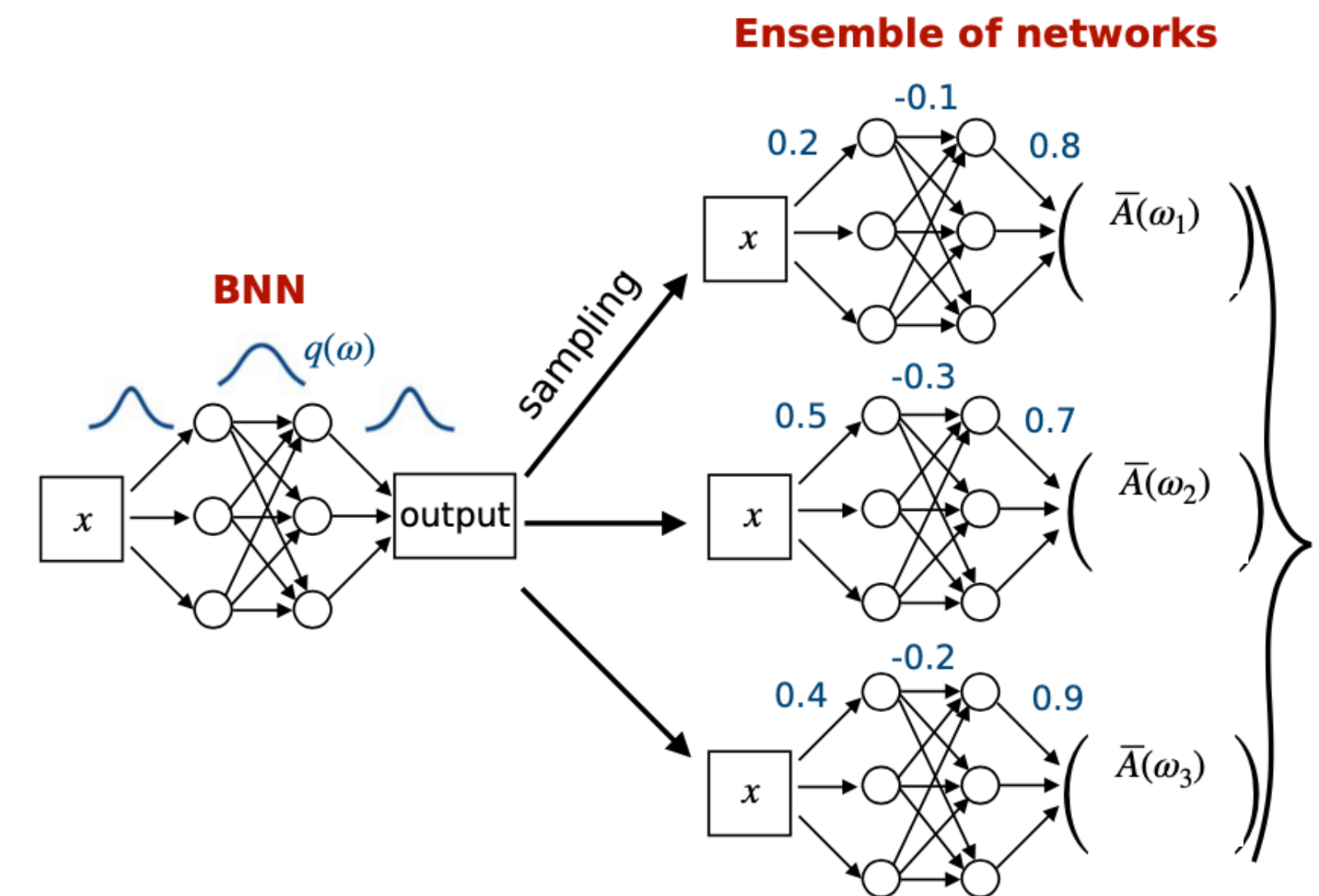

Bayesian Neural Network

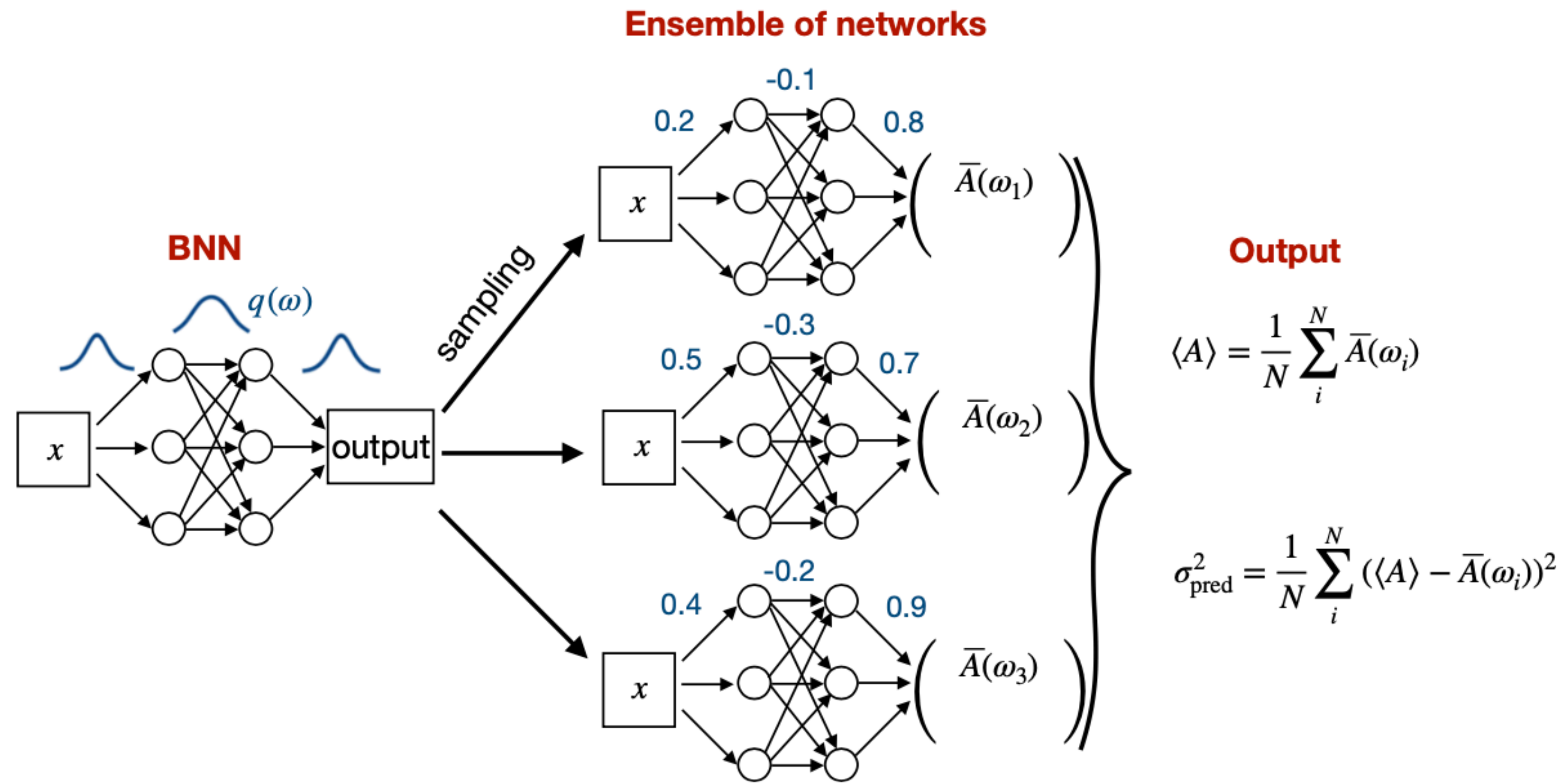

$$\mathcal{L} = \mathcal{L}_{INN} + KL_{\text{prior}}$$

$$= \sum_{n=1}^N \langle \log p_X(x_n | \theta) \rangle_{\theta \sim q_{\Phi}(\theta)} - KL(q_{\Phi}(\theta), p(\theta))$$

Bayesian generative networks

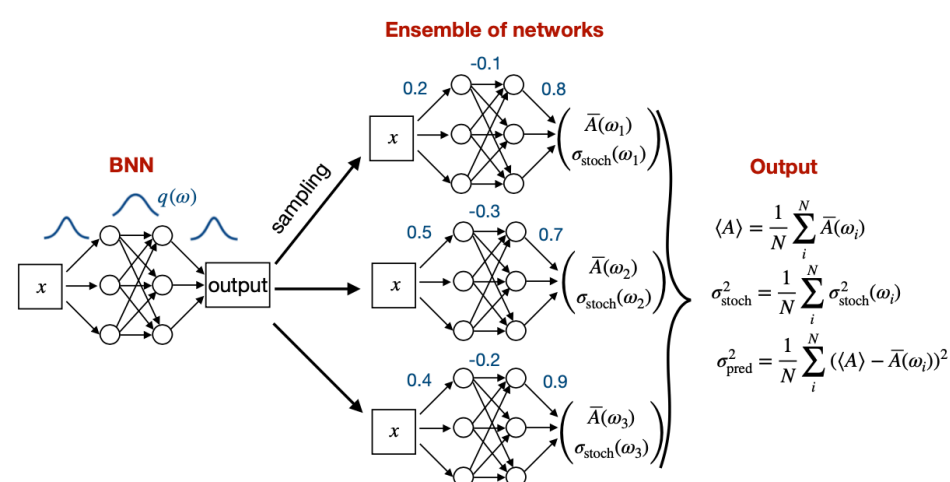
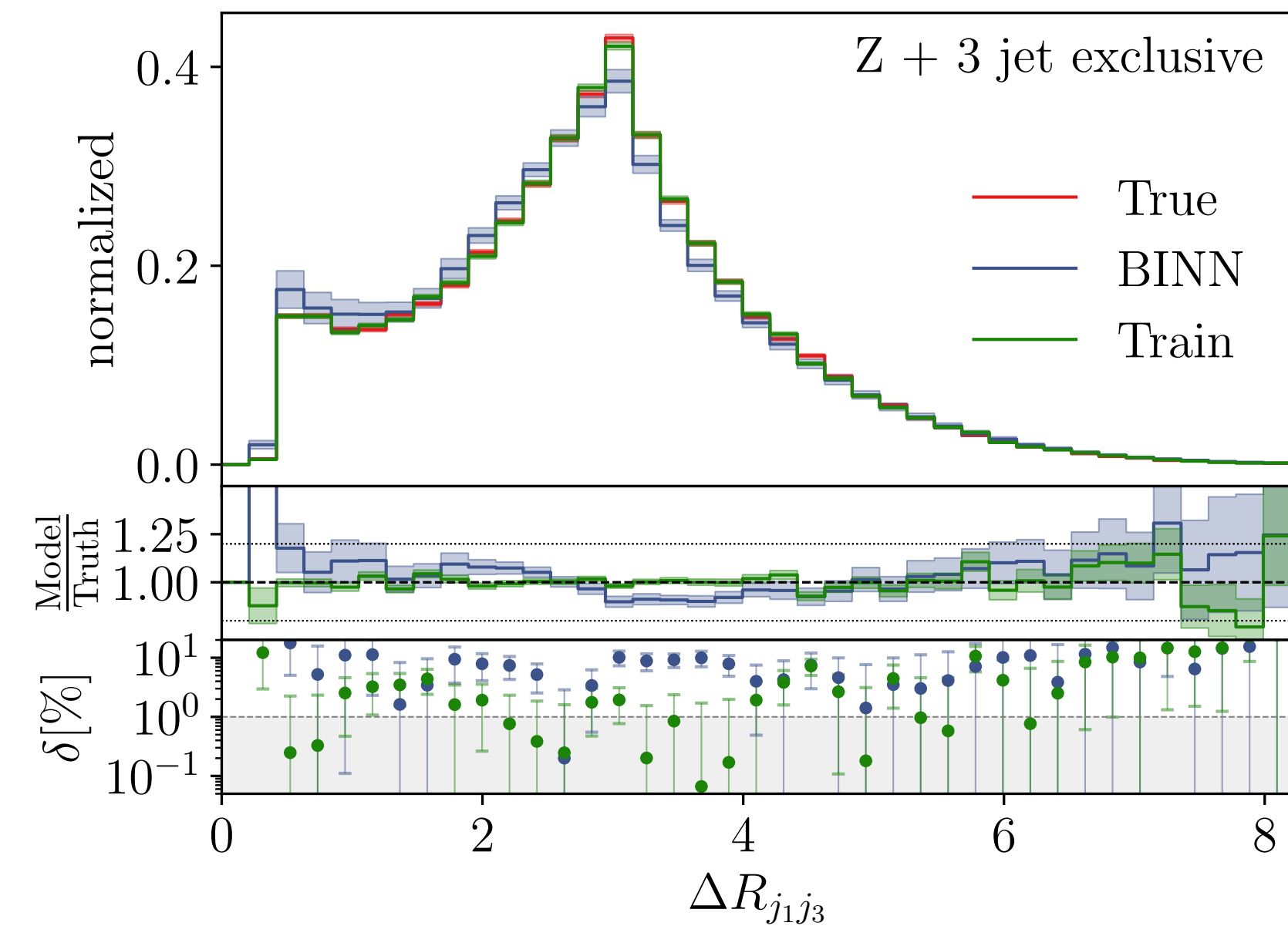
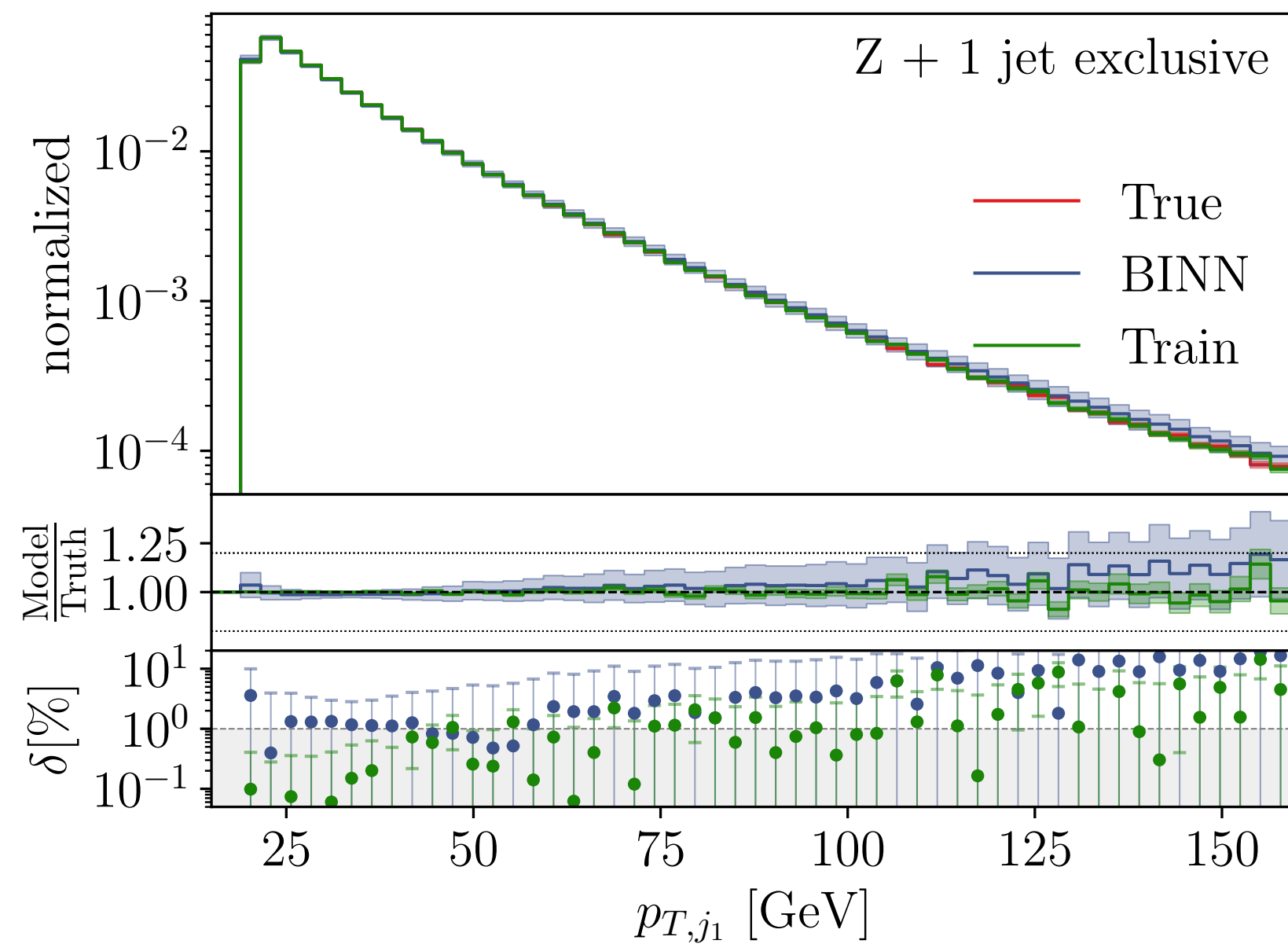

⇒ BINN captures uncertainty related to convergence and statistical uncertainties

⇒ BINN does not capture lack of expressiveness

Putting flows to work

Event generation

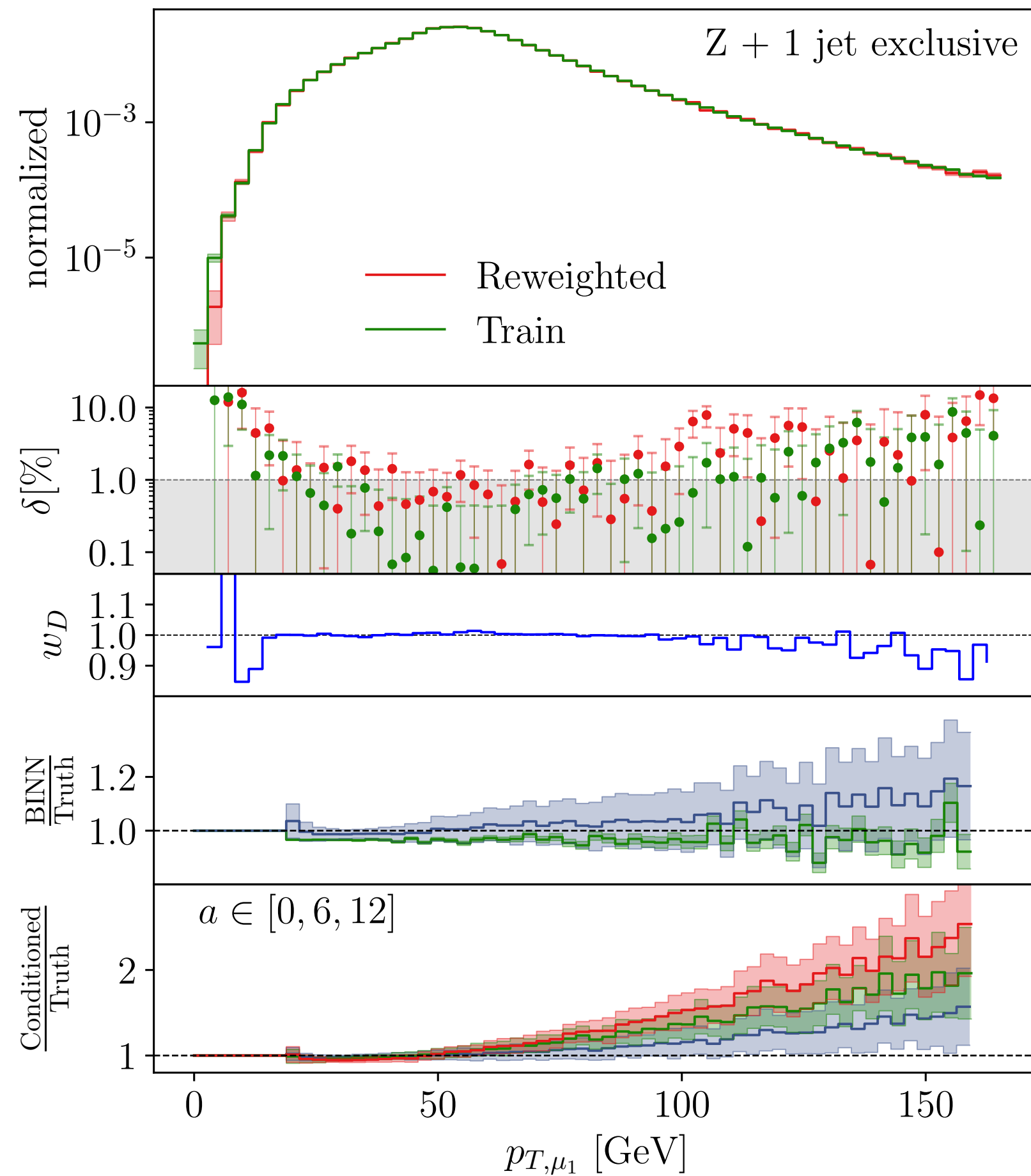

- Basis: INN
 - Phase space symmetries in architecture
 - Control via classifier D
 - $\frac{p_{\text{truth}}(x)}{p_{\text{INN}}(x)} = \frac{D(x)}{1 - D(x)}$
 - Precision via reweighting
 - Correct deviations of p_{INN}
- ➔ Uncertainty estimation via Bayesian NN
- ➔ Uncertainty propagation via conditioning

Inverting the simulation chain

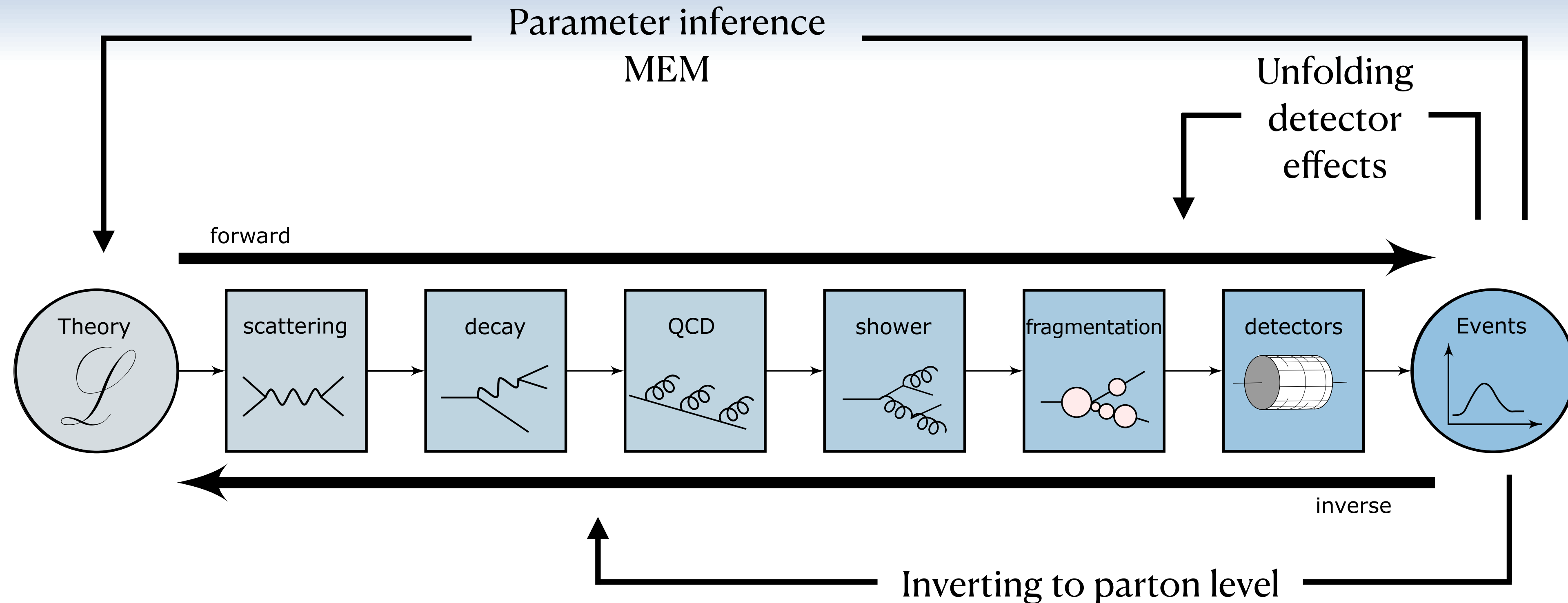

Requirements

- High-dimensional
- Bin independent
- Statistically well defined

ML unfolding methods

High-dimensional. Bin independent. Robust.

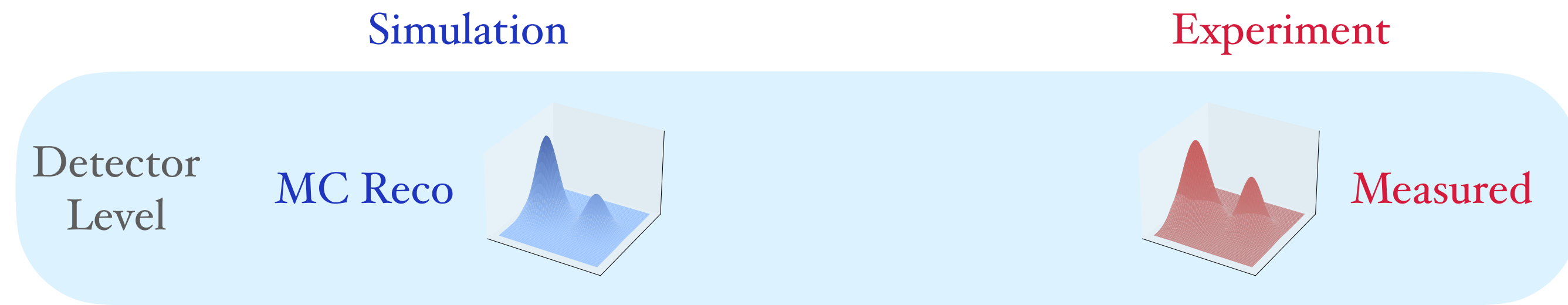

1. Train $c \downarrow \uparrow$ NN

2. Predict

Density based approach
Output: probability density per unfolded event

$$p(x_{part} | x_{reco})$$

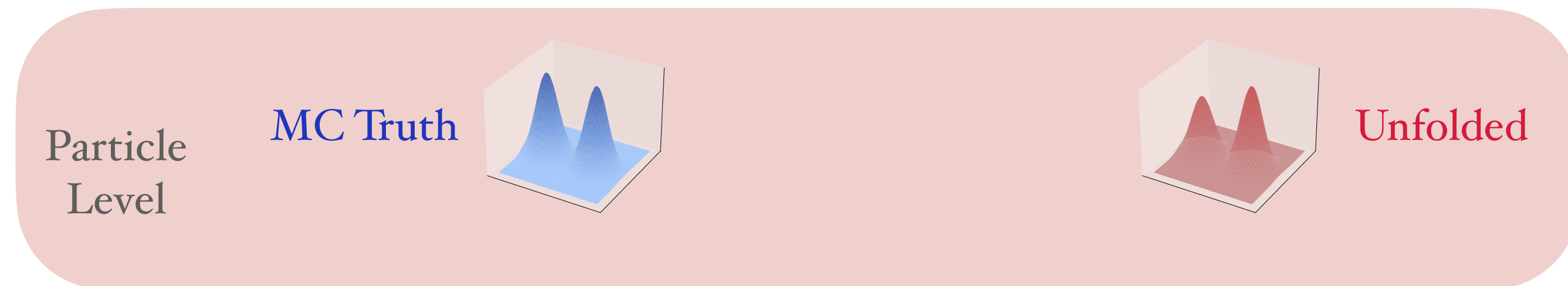

Inverting with invertible networks

$$\begin{pmatrix} x_{part} \\ r_{part} \end{pmatrix} \xleftarrow{\text{PYTHIA, DELPHES: } \bar{g}} \begin{pmatrix} x_{det} \\ r_{det} \end{pmatrix} \xrightarrow{\text{inversion: } \bar{g}}$$

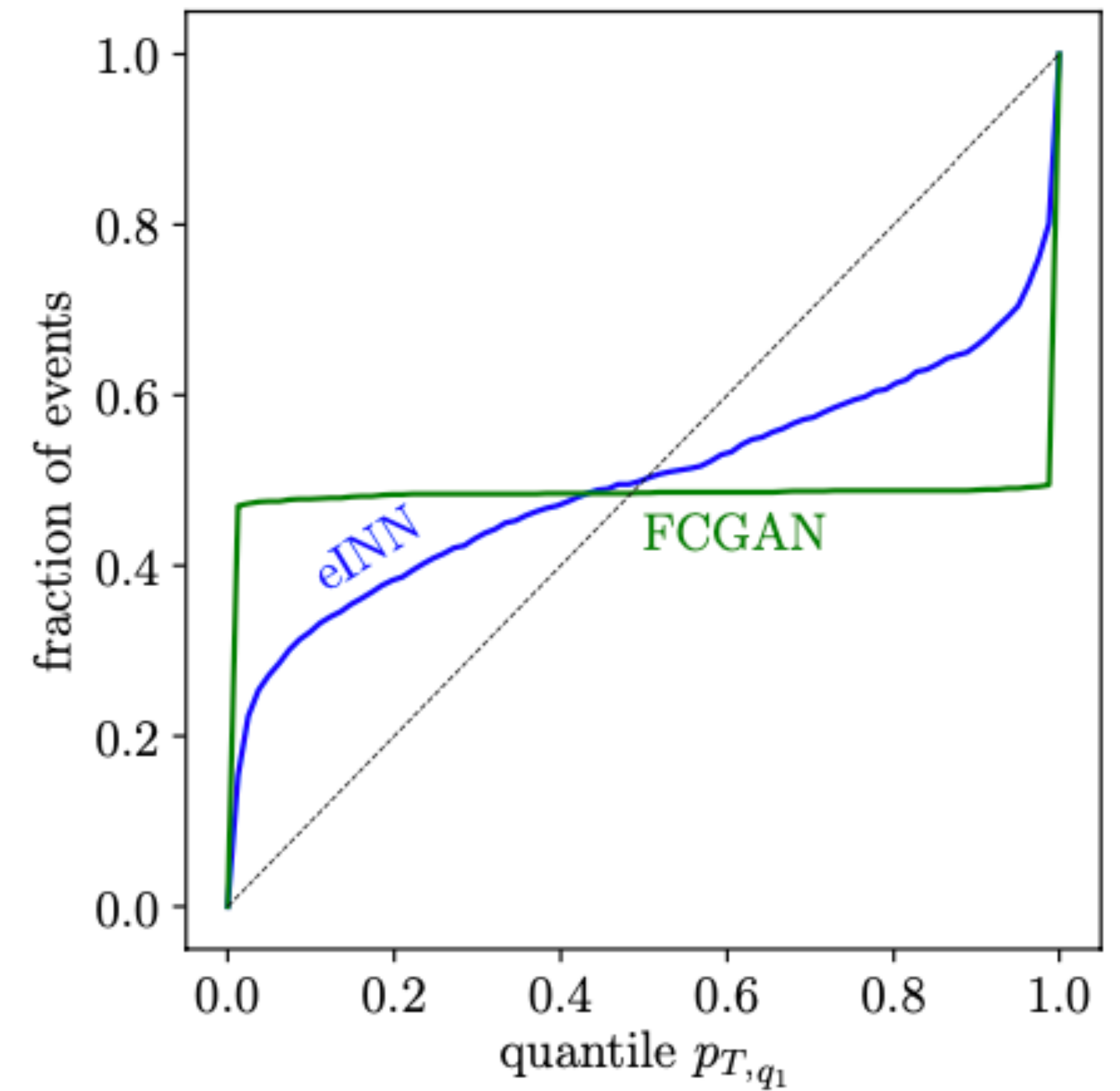
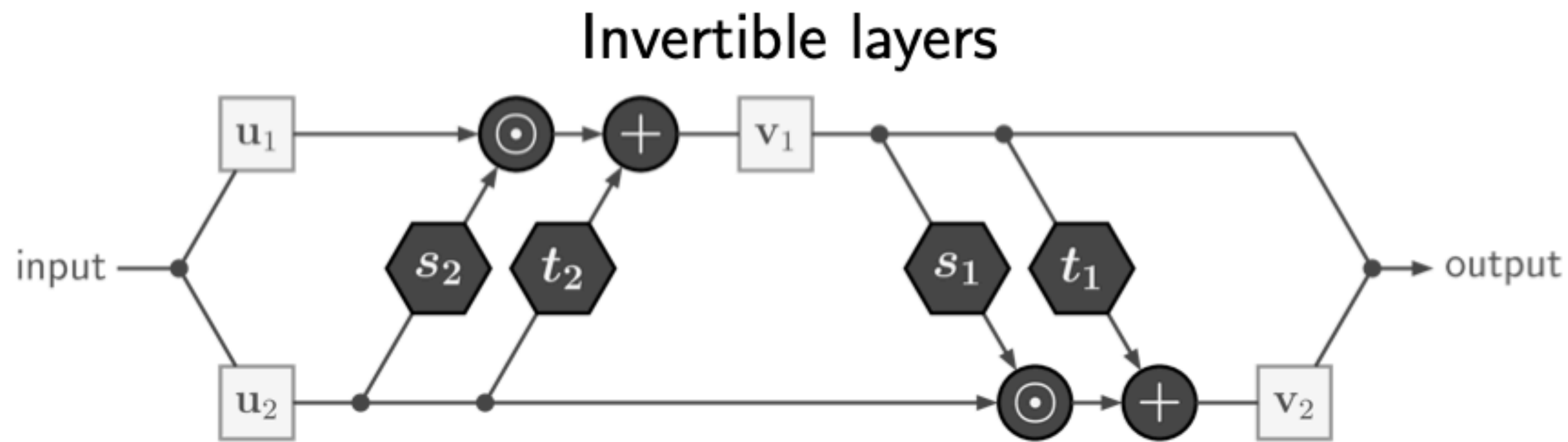

Inverting with invertible networks

$$\begin{pmatrix} x_{part} \\ r_{part} \end{pmatrix} \begin{array}{c} \xleftarrow{\text{PYTHIA, DELPHES: } g \rightarrow} \\ \xrightarrow{\text{inversion: } \bar{g}} \end{array} \begin{pmatrix} x_{det} \\ r_{det} \end{pmatrix}$$

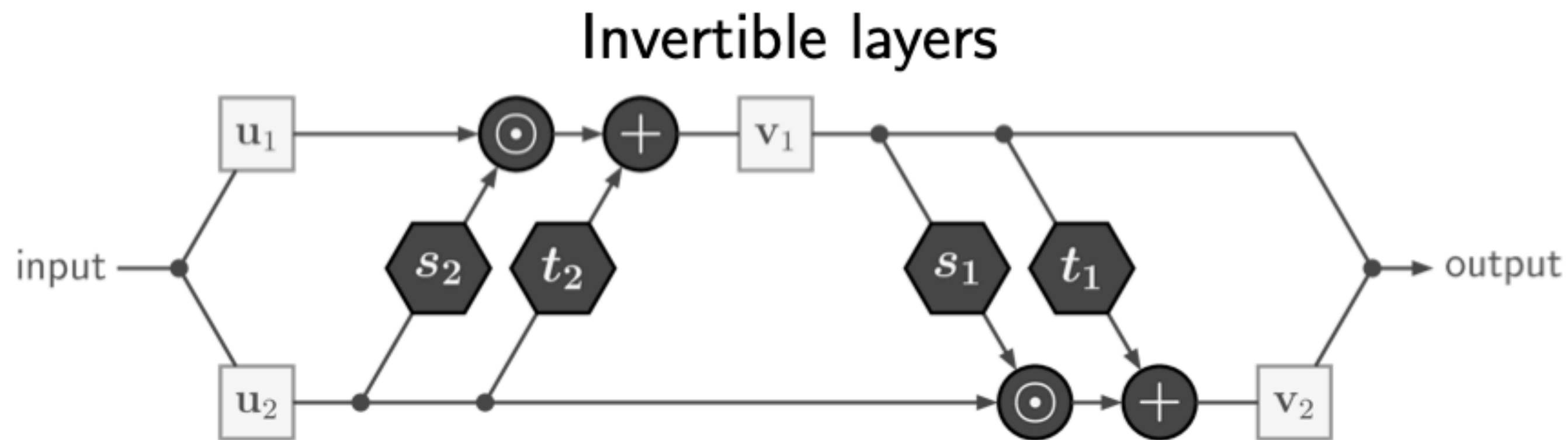

$$\mathcal{L} = \mathcal{L}_{part} + \mathcal{L}_{det} + \mathcal{L}_r$$

$$\begin{aligned} \mathcal{L}_{part} = & \lambda_1 \|x_{part} - \bar{g}_{part}(x_{det}, r_{det})\| \\ & + \lambda_2 \text{MMD}(x_{part}, \bar{g}_{part}(x_{det}, r_{det})) \end{aligned}$$

$$\begin{aligned} \mathcal{L}_{det} = & \lambda_3 \|x_{det} - g_{det}(x_{part}, r_{part})\| \\ & + \lambda_4 \text{MMD}(x_{det}, g_{det}(x_{part}, r_{part})) \end{aligned}$$

$$\begin{aligned} \mathcal{L}_r = & \lambda_5 \text{MMD}(\bar{g}_r(x_{det}, r_{det}), \mathcal{N}) \\ & + \lambda_6 \text{MMD}(g_r(x_{part}, r_{part}), \mathcal{N}) \end{aligned}$$

cINN unfolding

Given a reconstructed event:
What is the probability distribution at particle level?

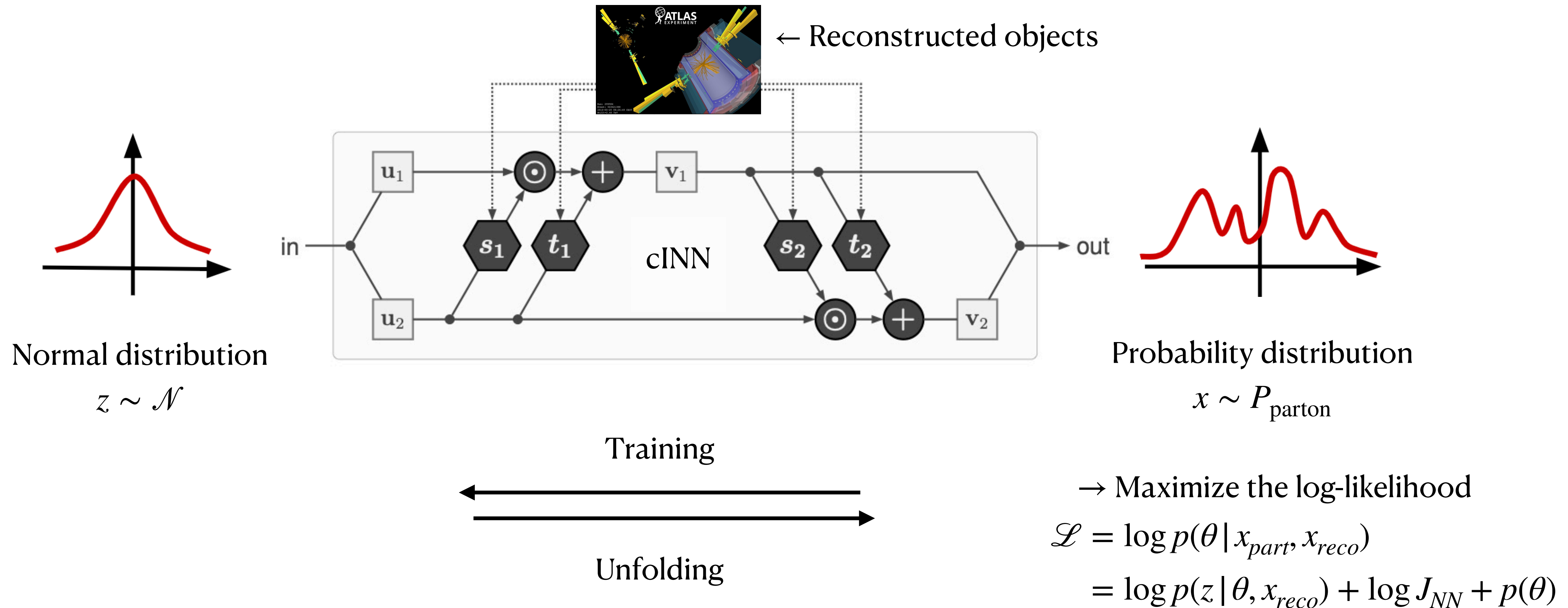

Inverting inclusive distributions

$$pp > WZ > q\bar{q}l^+l^- + \text{ISR} \rightarrow 2/3/4 \text{ jet events}$$

Training on inclusive dataset

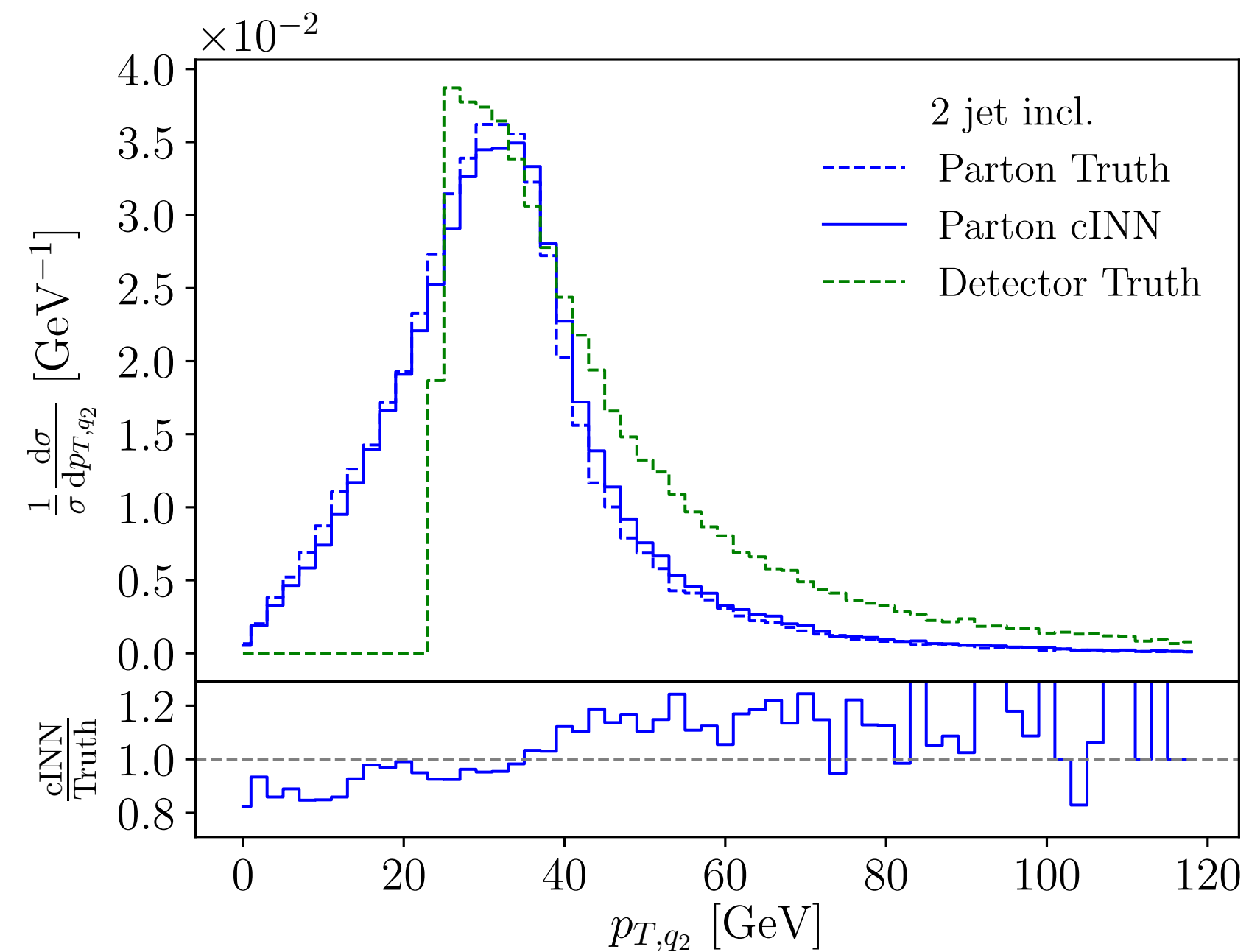

Evaluate exclusive 2/3/4 jet events

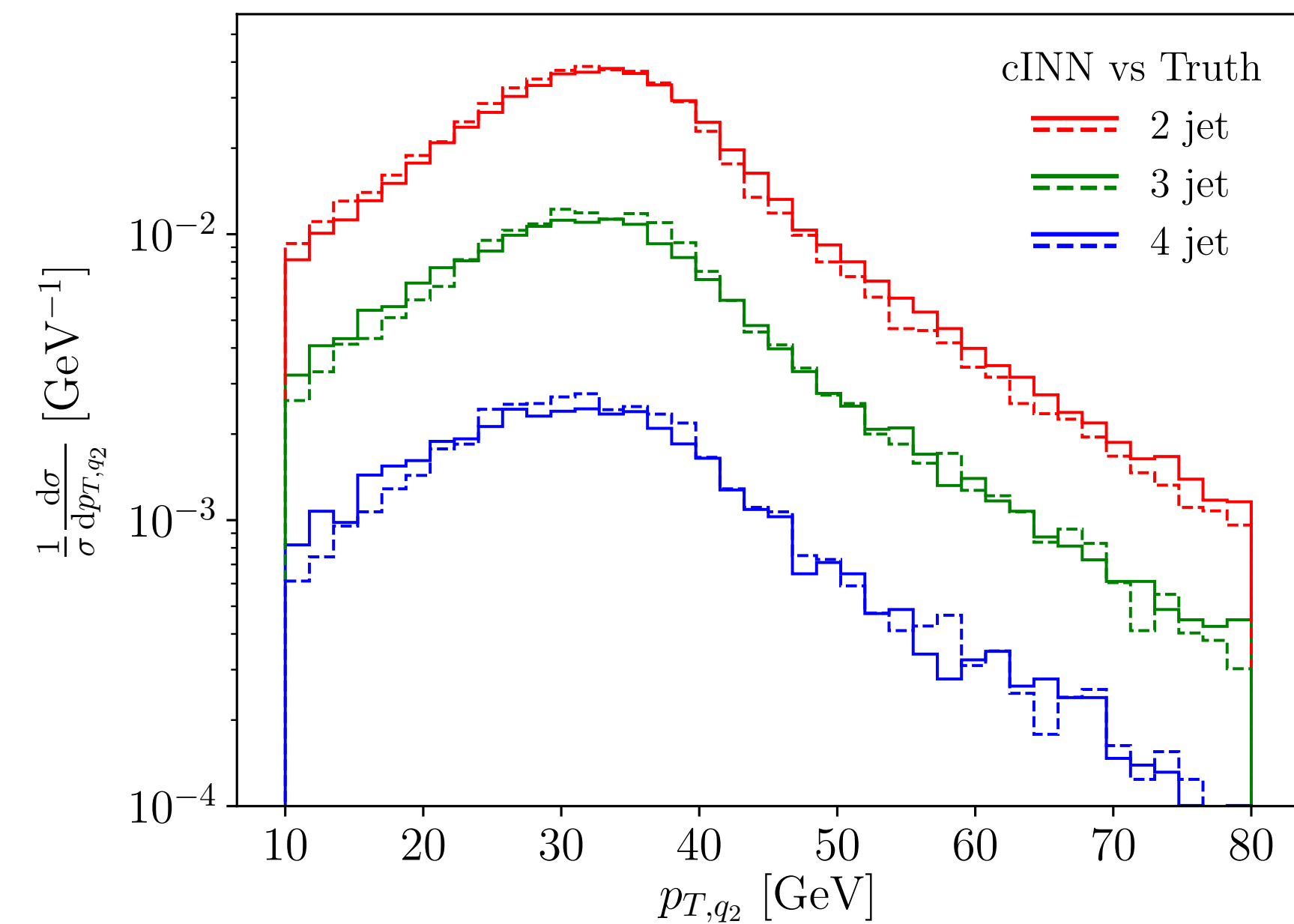

- High-dimensional
- Bin-independent
- Statistically well defined ?

M. Bellagente et al. [2006.06685]

Event-wise unfolding

No deterministic mapping!

Check calibration of probability density for individual event unfolding

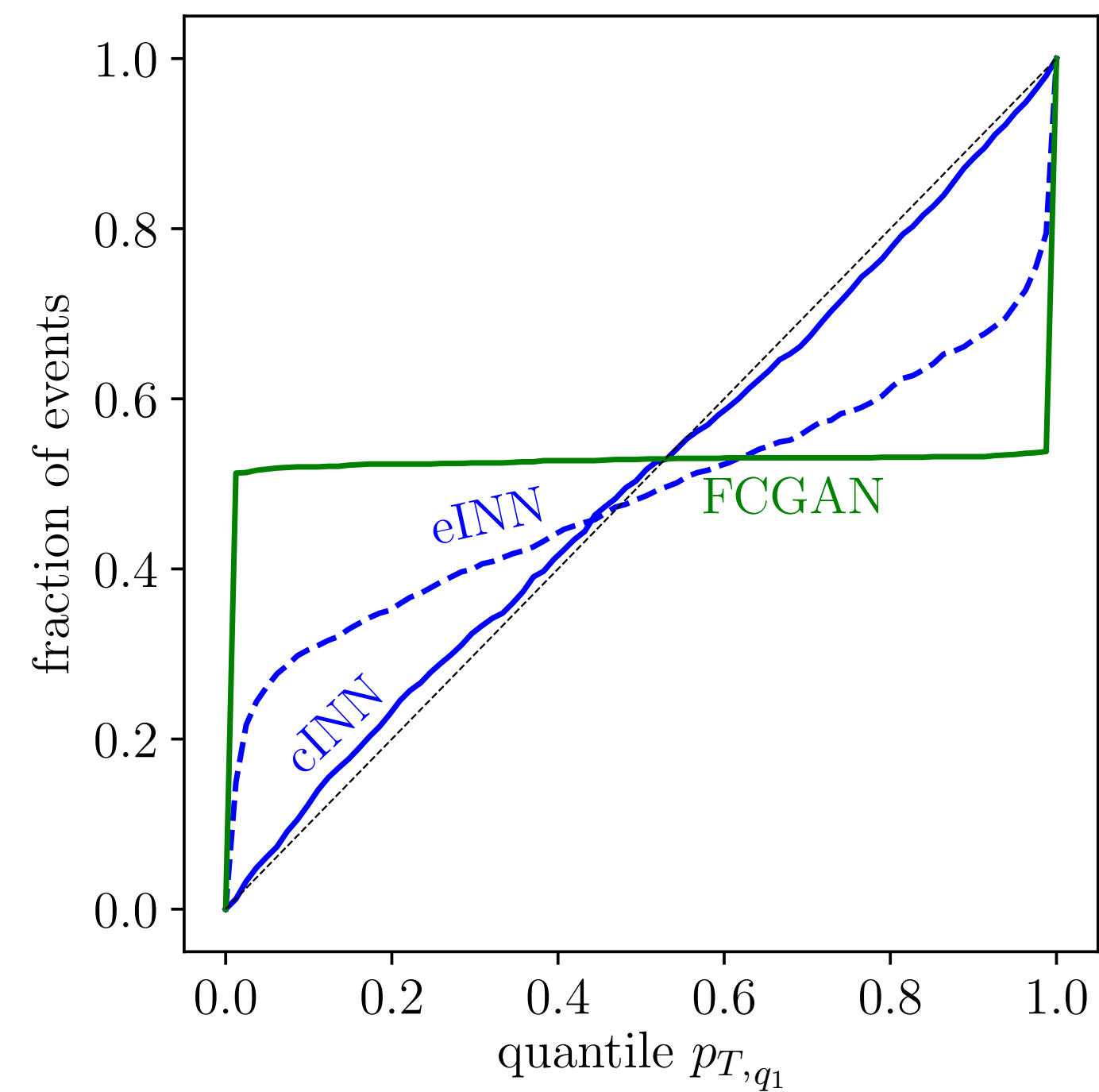
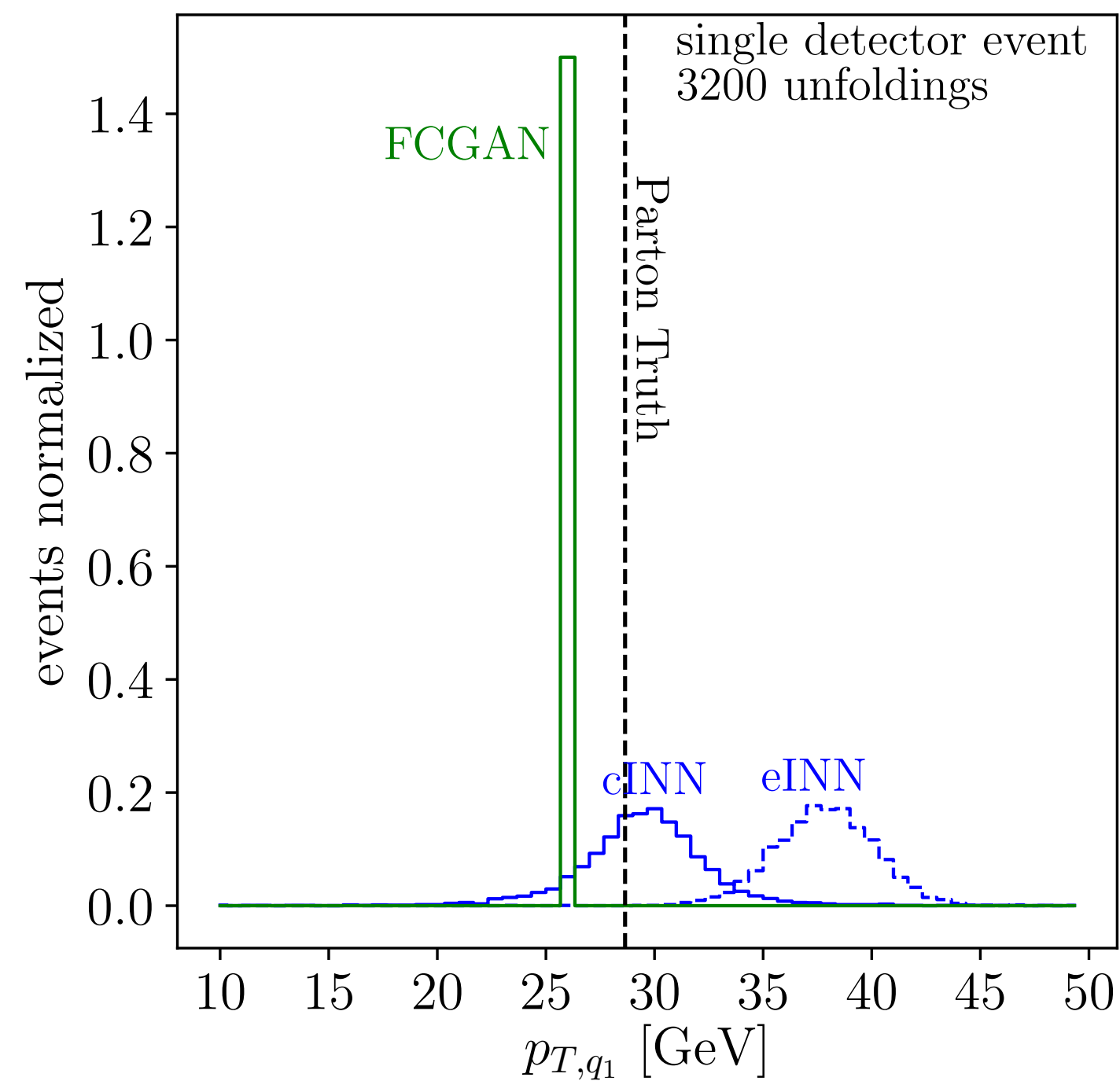

- High-dimensional
- Bin-independent
- Statistically well defined

M. Bellagente et al. [2006.06685]

Inference with cINNs

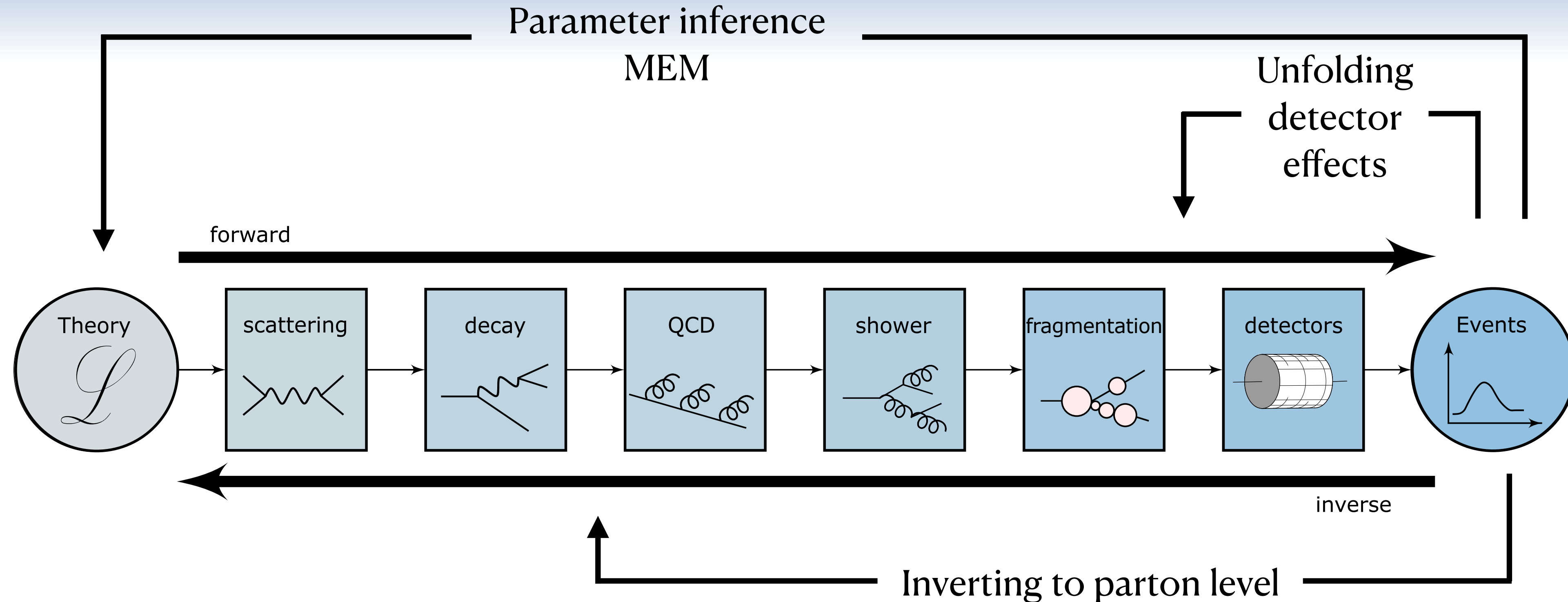

Likelihood known

- Theory parameter of Lagrangian
 - cINN: parton level \leftrightarrow detector level
- ➡ Matrix Element Method

Likelihood unknown/intractable

- Only have simulations
 - cINN: observations \rightarrow theory parameters
- ➡ BayesFlow

Simulation based inference: BayesFlow

Learn posterior distribution $p(\text{parameters} \mid \text{measured data})$ from simulations

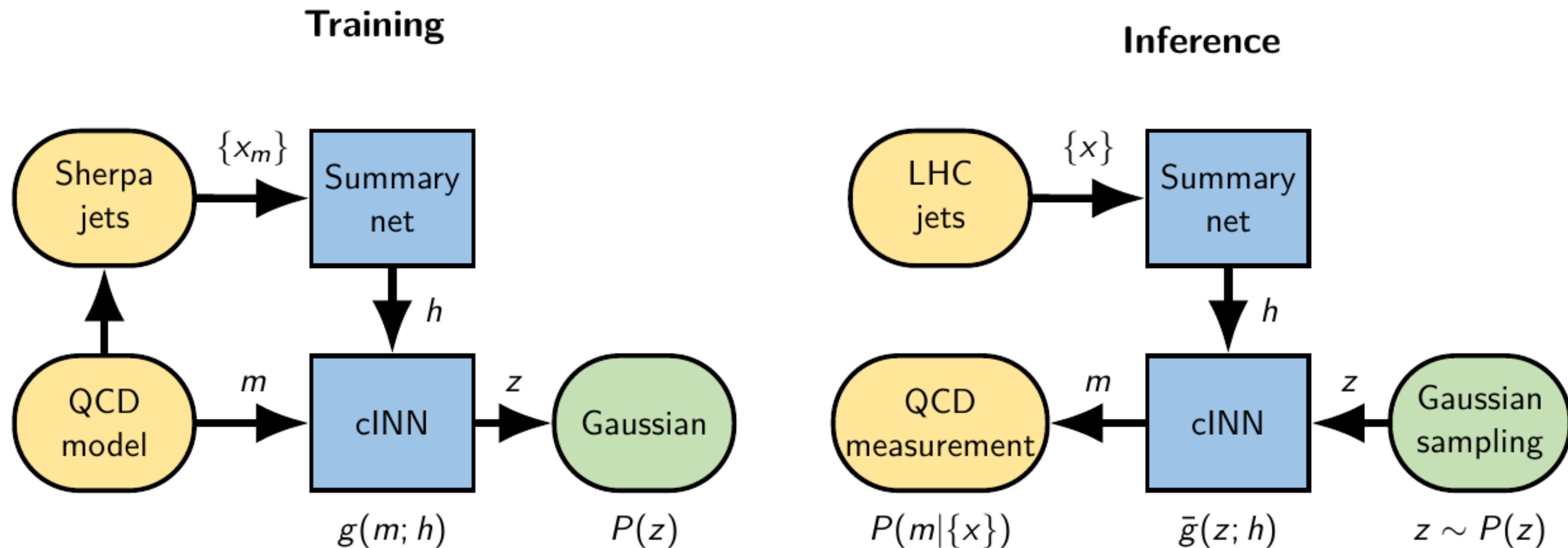

S. Bieringer et al. [2012.09873]

S. Radev et al. [2003.06281]

BayesFlow

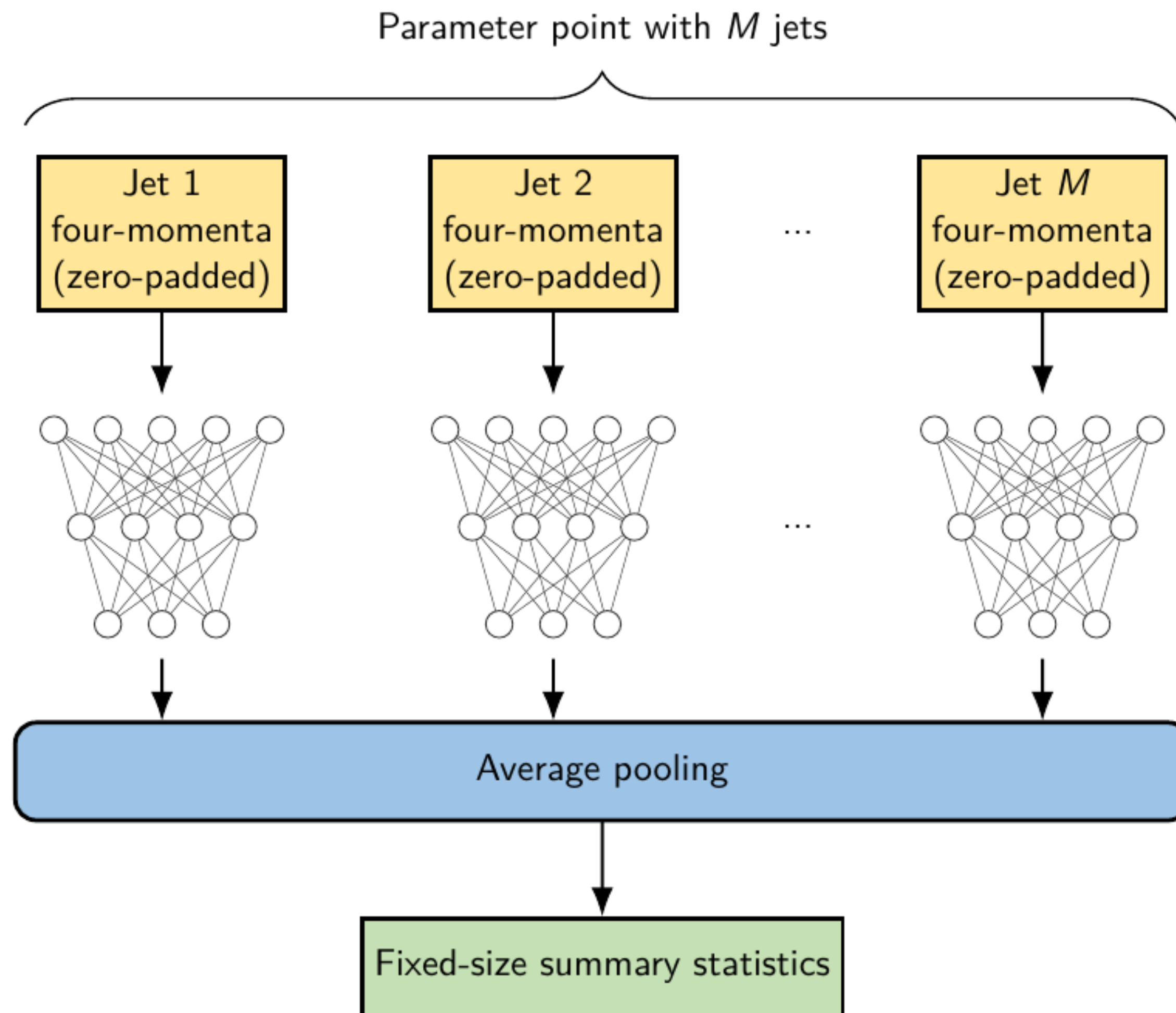

Flexible summary net

- Single measurements
- Sets of measurements
- Time series data
- ...

➔ Unsupervised learning of summary statistics

S. Bieringer et al. [2012.09873]

S. Radev et al. [2003.06281]

BayesFlow

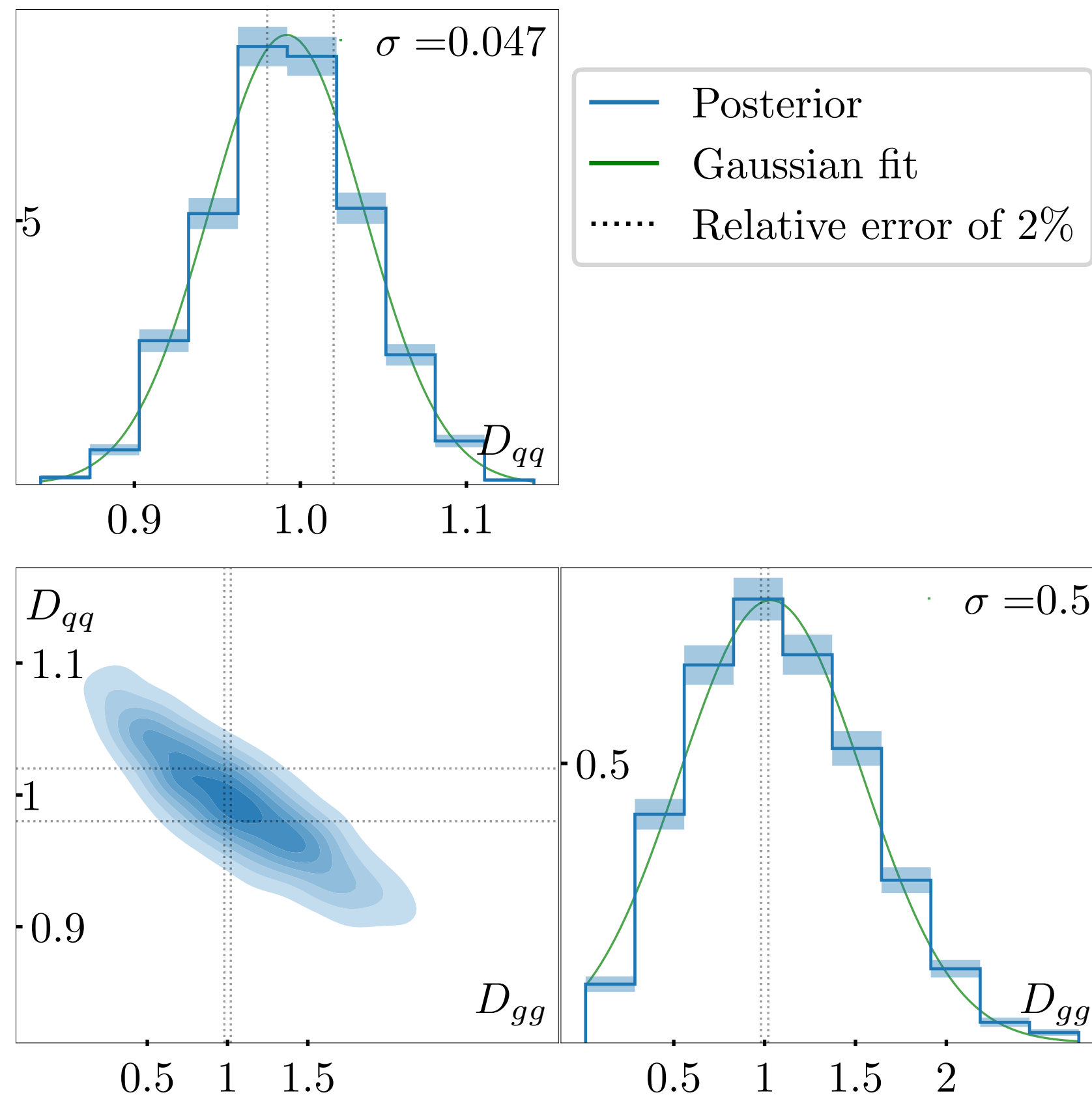

Pro:

- No likelihood needed
- Train once, infer multiple times
- Flexible summary net
- Works on high-dimensional data

Contra:

- Bayesian approach: Prior dependent
- Expensive for large number of observations

S. Bieringer et al. [2012.09873]

S. Radev et al. [2003.06281]

Generative networks for better LHC physics

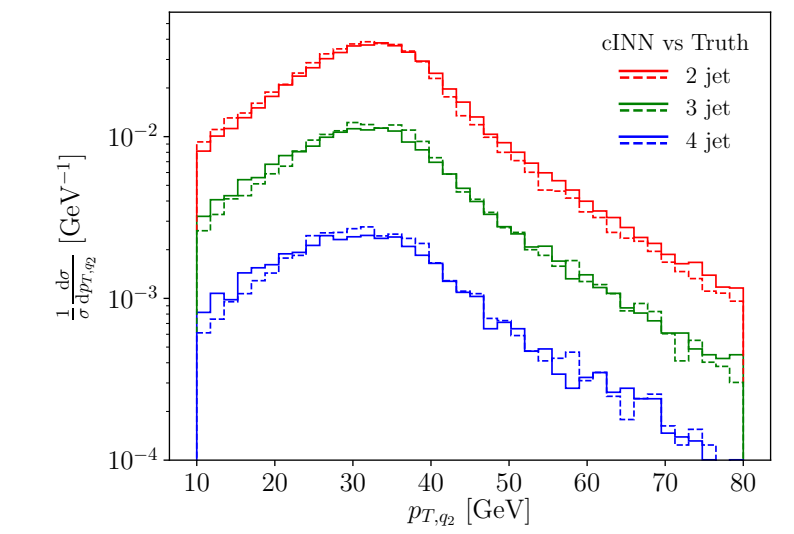
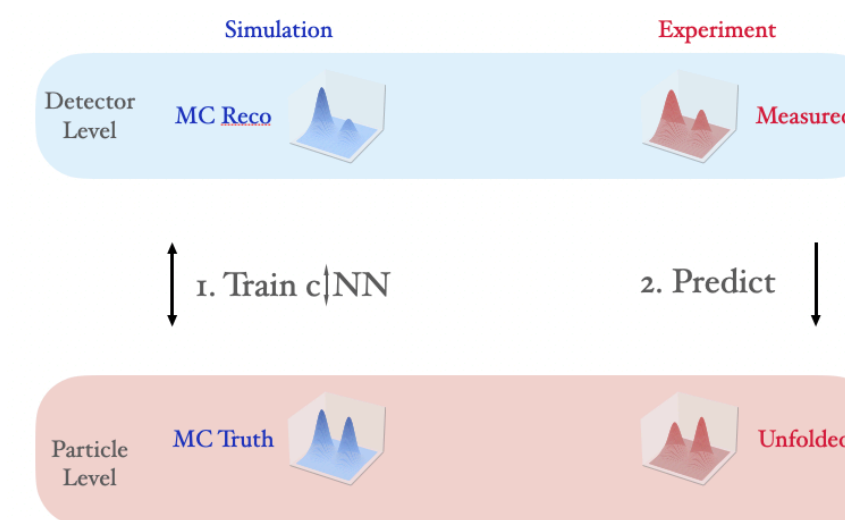
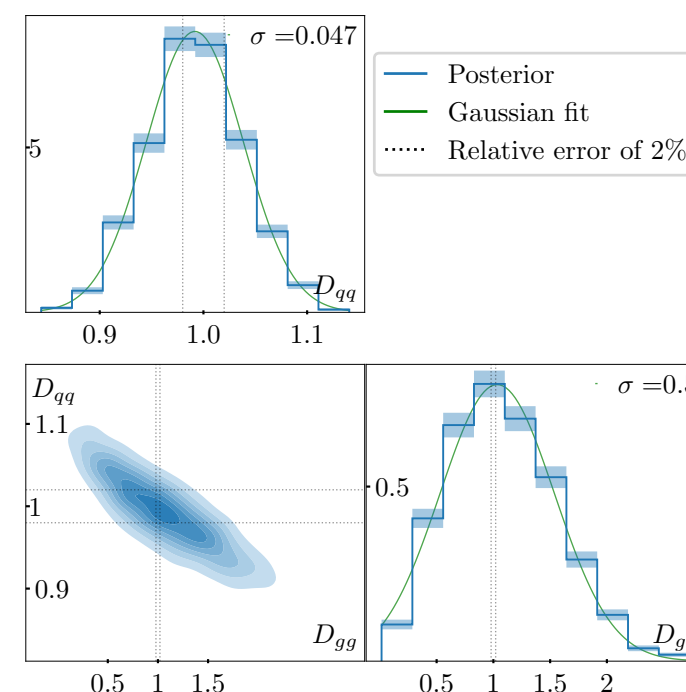
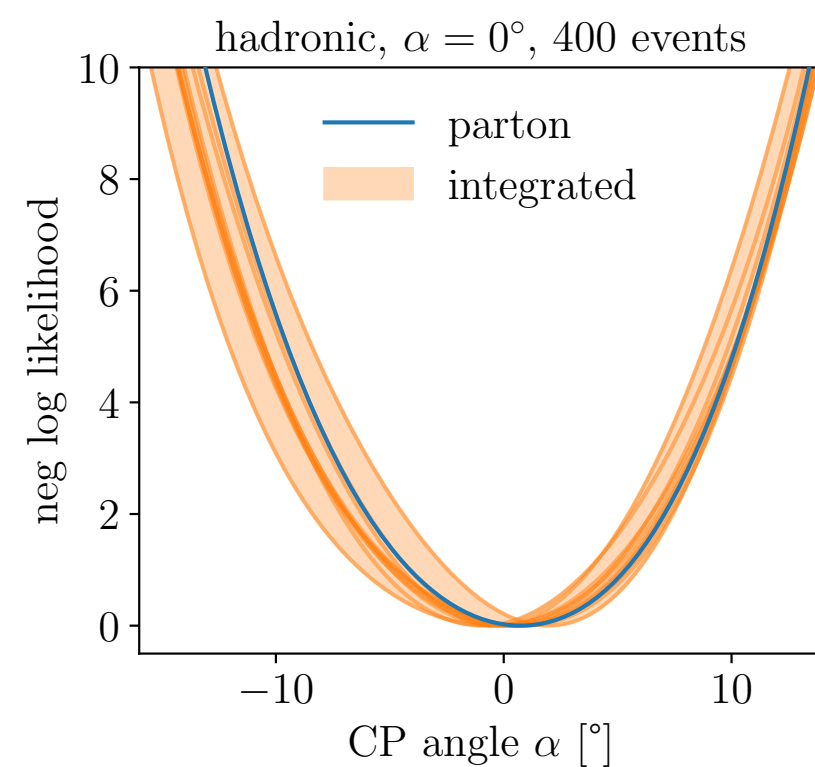
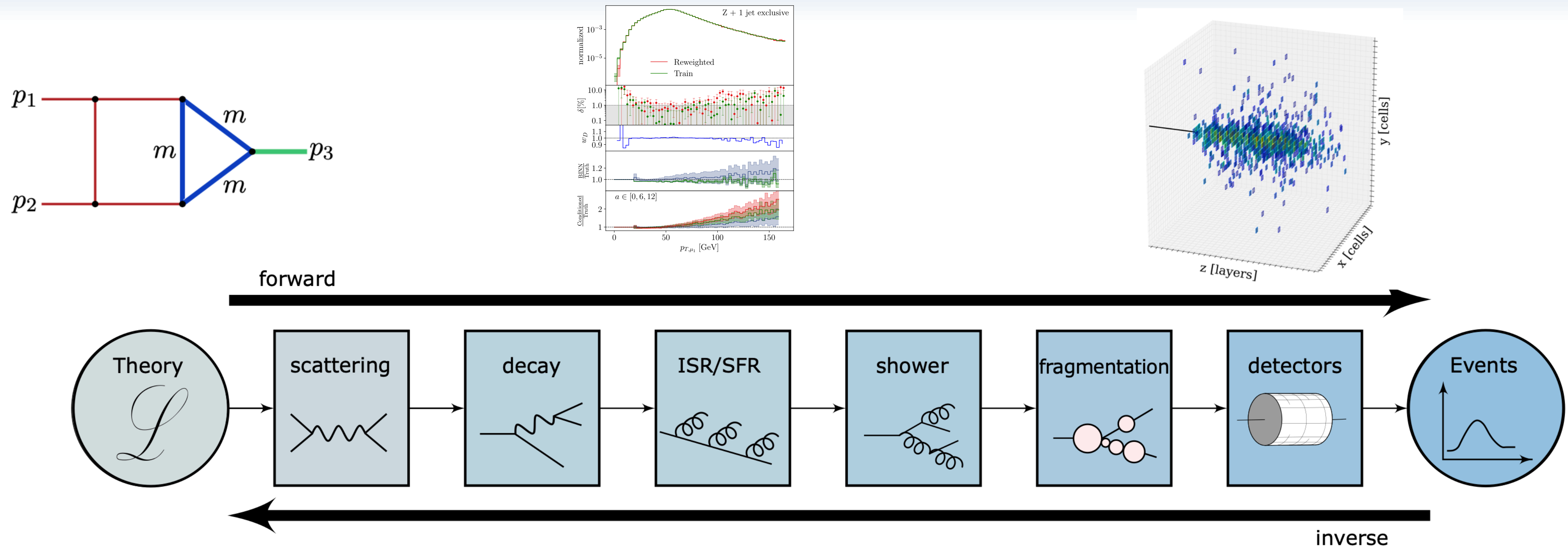

New data are currently on their way...

BACK UP

One problem remains (work in progress)

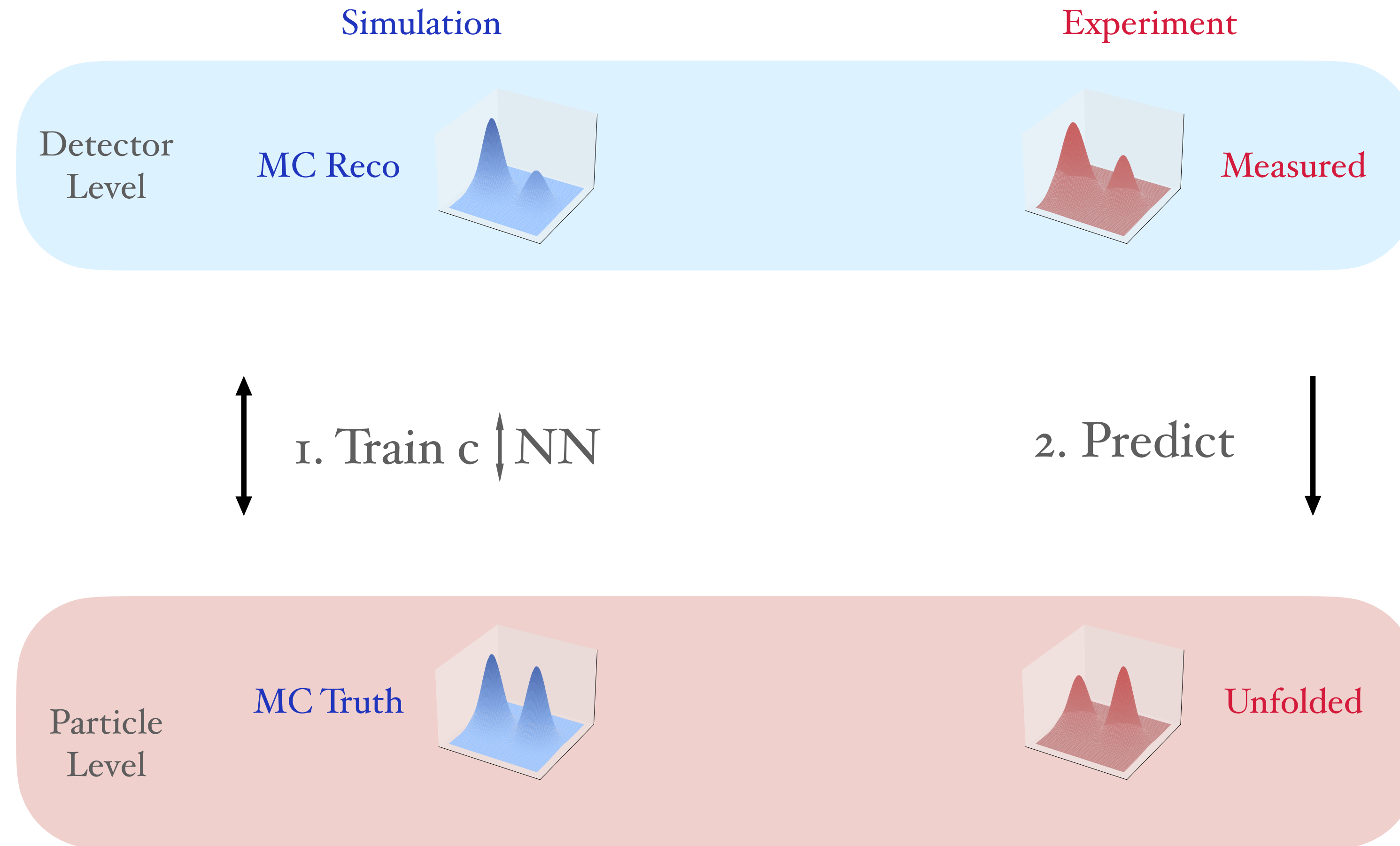

One problem remains

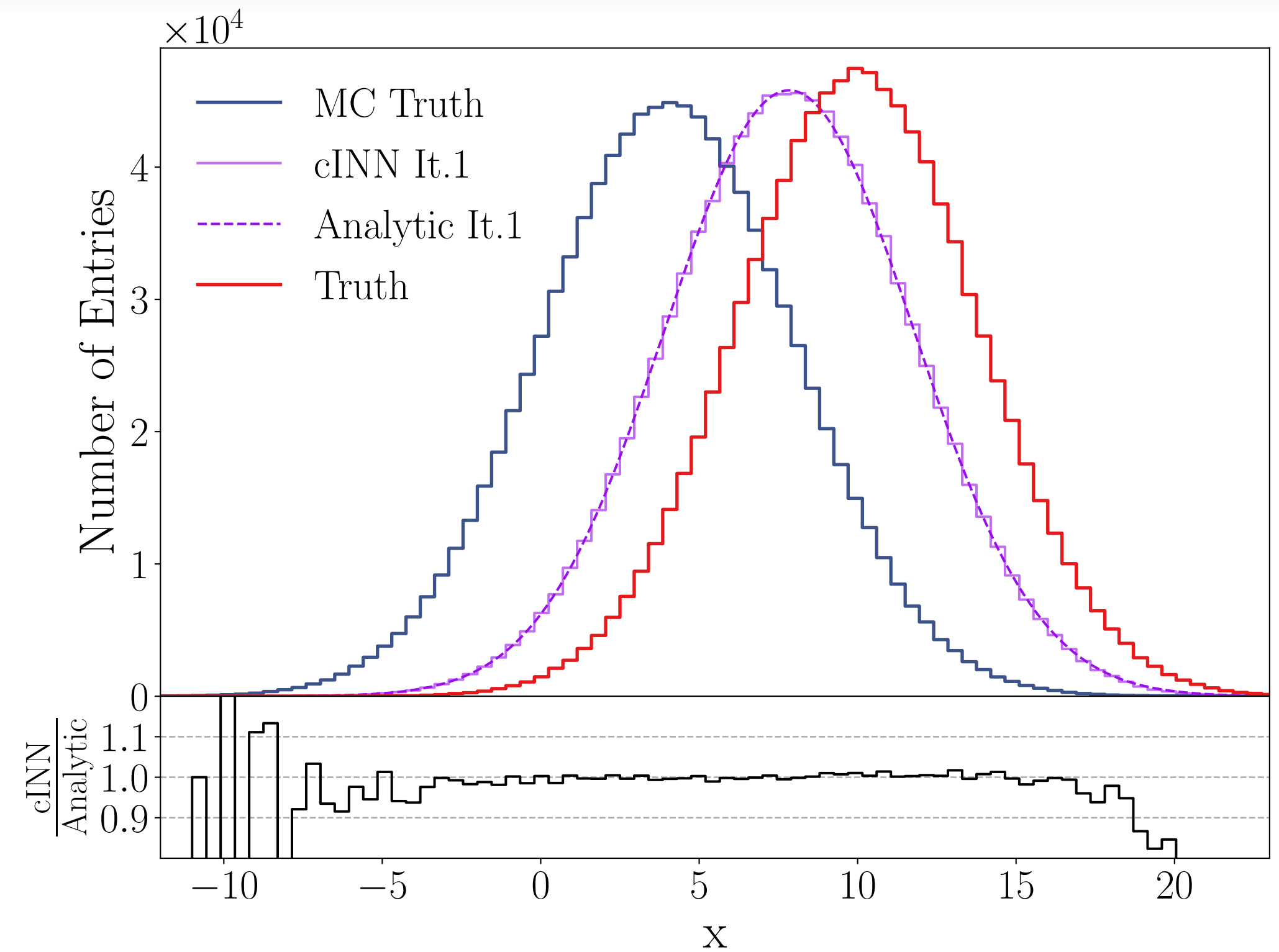
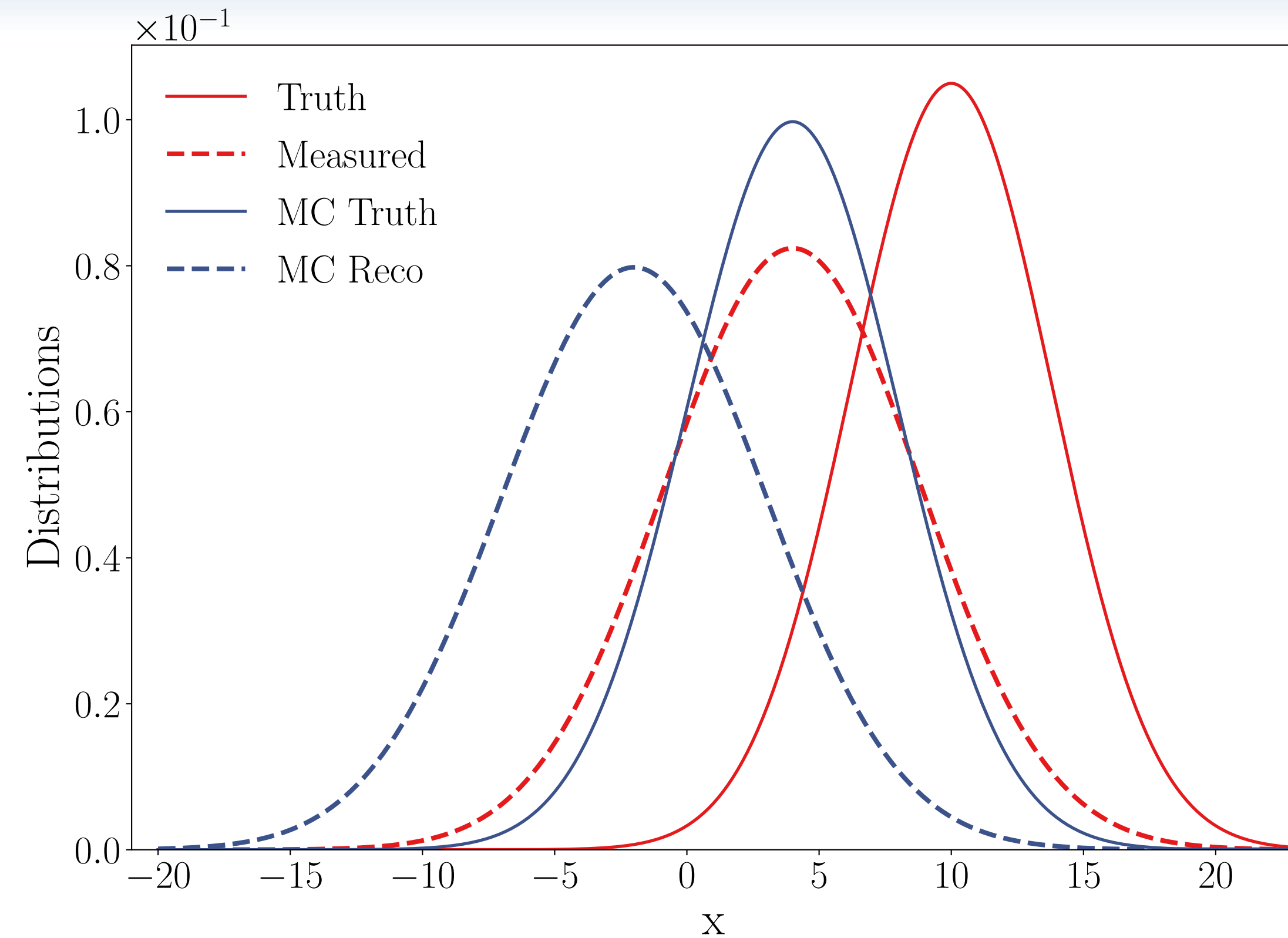

$p(x_{reco} | x_{parton})$ is the same, but $p(x_{parton} | x_{reco})$ is not

One problem remains

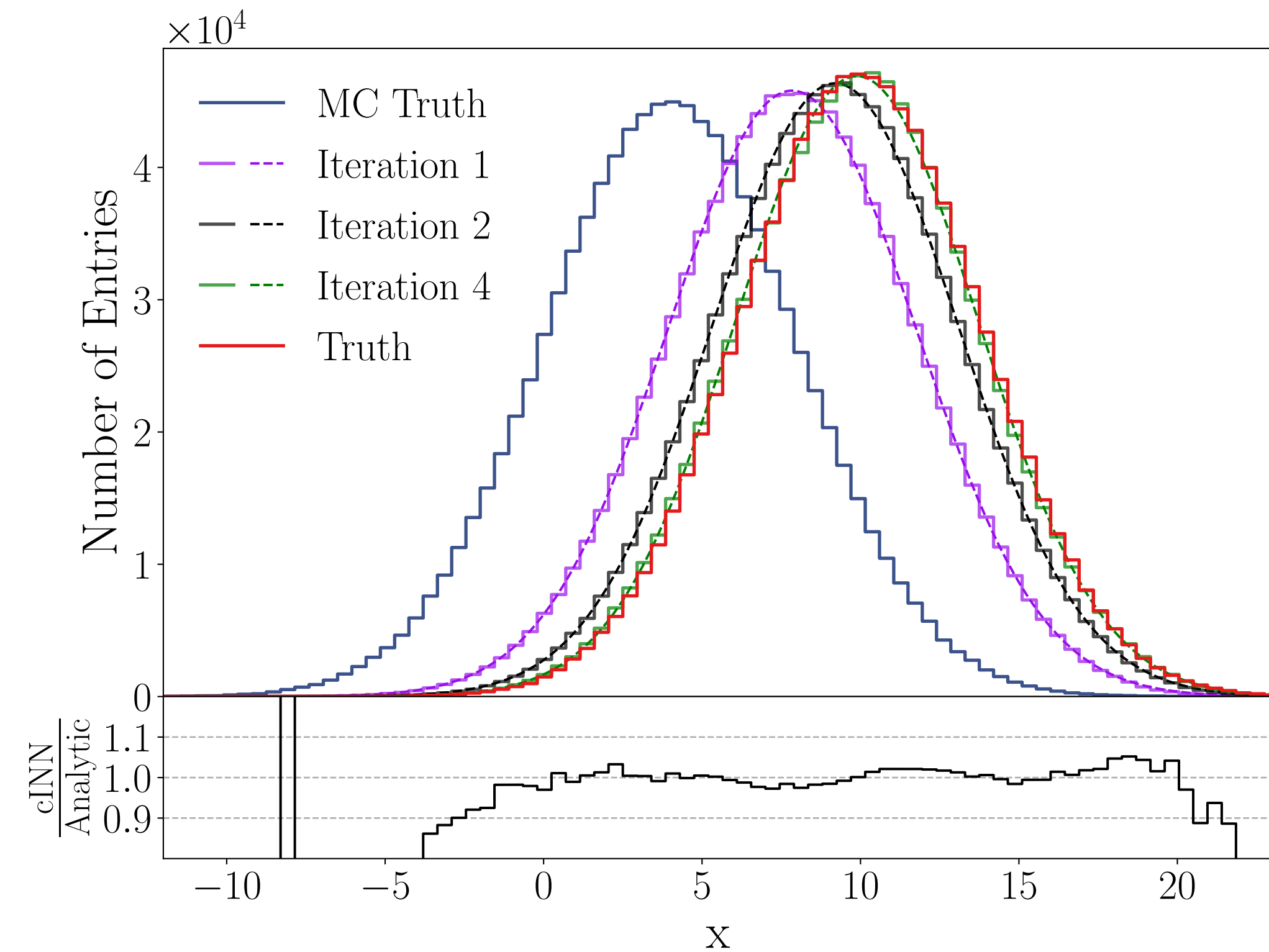
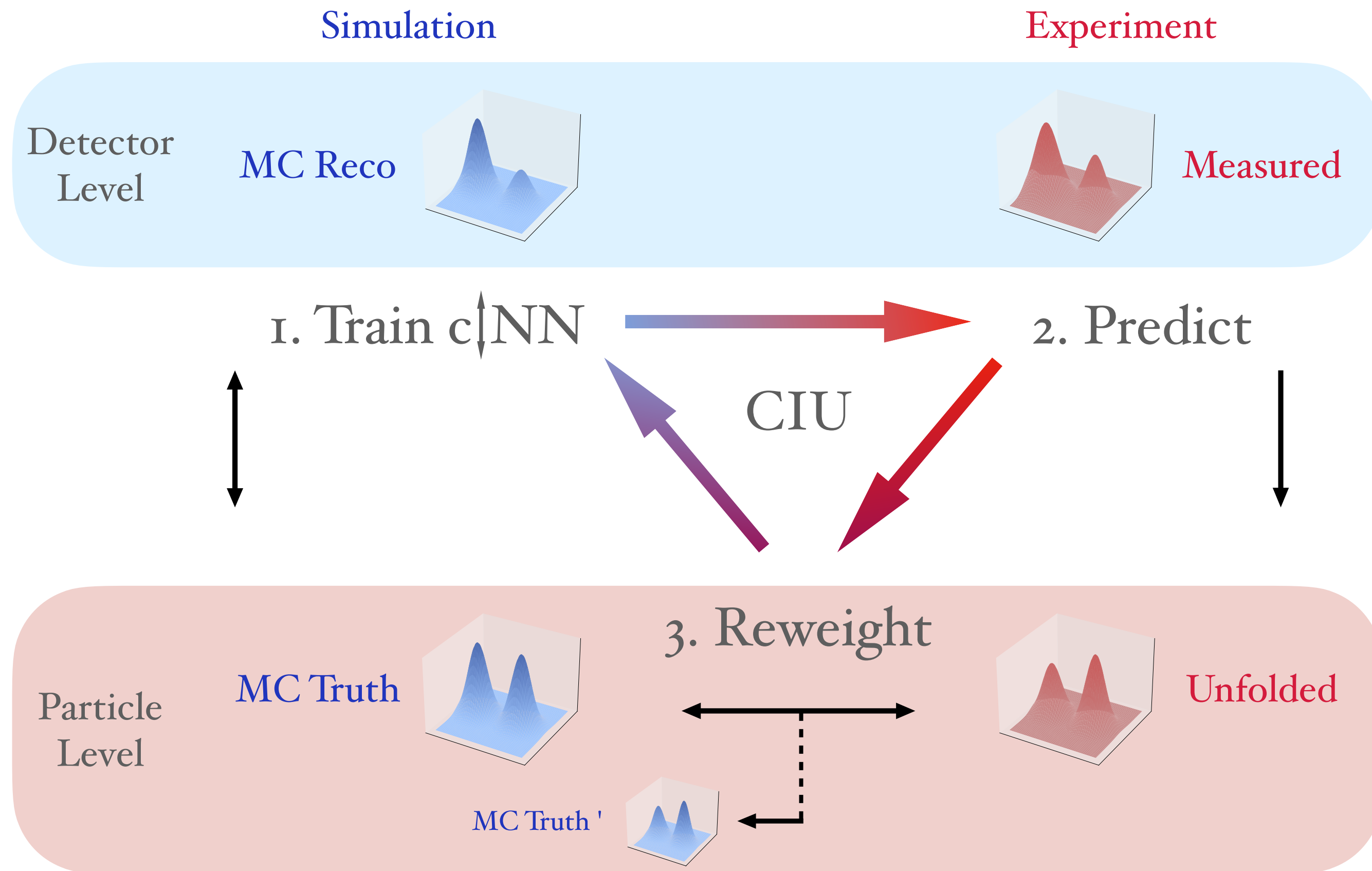

Multi-loop calculations with NNs

Precision predictions based on loop diagrams

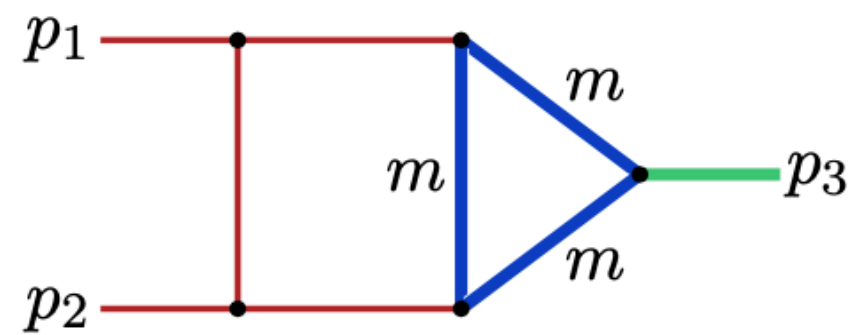

Analytic expression for loop amplitude

$$G = \int_{-\infty}^{\infty} \left(\prod_{l=1}^L \frac{d^D k_l}{i\pi^{\frac{D}{2}}} \right) \prod_{j=1}^N \frac{1}{(q_j^2 - m_j^2 + i\delta)^{\nu_j}}$$

$$= \int_0^1 \prod_{j=1}^{N-1} dx_j x_j^{\nu_j-1} \frac{U^{\nu-(L+1)D/2}}{F^{\nu-LD/2}} = \int_0^1 \prod_{j=1}^{N-1} dx_j I(\vec{x})$$

Rewrite with
Feynman parameters

Still contains singularities

Multi-loop calculations with NNs

Precision predictions based on loop diagrams

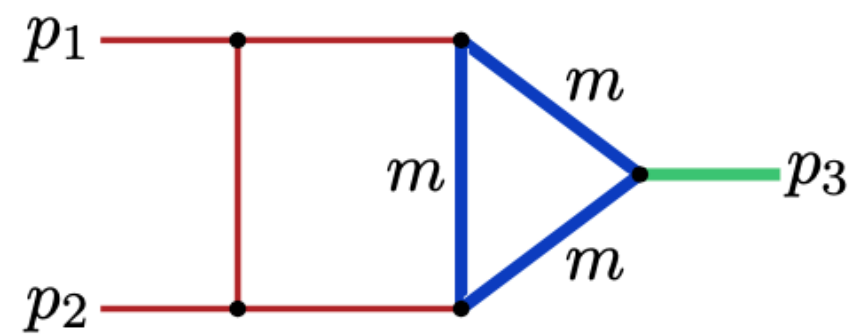

Solved by contour deformation due to Cauchy's theorem

$$\int_0^1 \prod_{j=1}^N dx_j I(\vec{x}) = \int_0^1 \prod_{j=1}^N dx_j \det\left(\frac{\partial \vec{z}(\vec{x})}{\partial \vec{x}}\right) I(\vec{z}(\vec{x}))$$

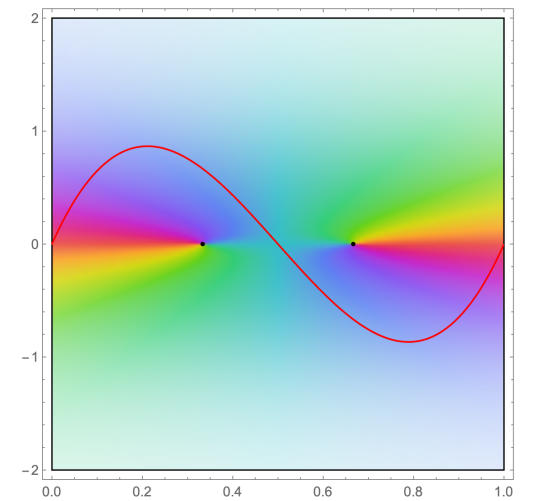

Analytic expression for loop amplitude

$$G = \int_{-\infty}^{\infty} \left(\prod_{l=1}^L \frac{d^D k_l}{i\pi^{D/2}} \right) \prod_{j=1}^N \frac{1}{(q_j^2 - m_j^2 + i\delta)^{\nu_j}}$$

$$= \int_0^1 \prod_{j=1}^{N-1} dx_j x_j^{\nu_j-1} \frac{U^{\nu-(L+1)D/2}}{F^{\nu-LD/2}} = \int_0^1 \prod_{j=1}^{N-1} dx_j I(\vec{x})$$

Rewrite with Feynman parameters

Still contains singularities



Optimal parametrization = minimal variance

Turn it into an ML Problem

Integration with normalizing flows

Numeric evaluation of integral $G = \int_0^1 dx_j \det\left(\frac{\partial \vec{z}(\vec{x})}{\partial \vec{x}}\right) I(\vec{z}(\vec{x}))$

Parametrization $\rightarrow z = \text{INN}(x)$

Minimize **variance** $\rightarrow \text{loss } \mathcal{L} = \sigma_n^2 = \frac{1}{n-1} \sum_{i=1}^n \left| \det\left(\frac{\partial \vec{z}(\vec{x}_{(i)})}{\partial \vec{x}_{(i)}}\right) I(\vec{z}(\vec{x}_{(i)})) - \langle I \rangle \right|^2$

Normalizing flow networks

- + Bijective mapping
- + Tractable Jacobian
- + Combine many blocks

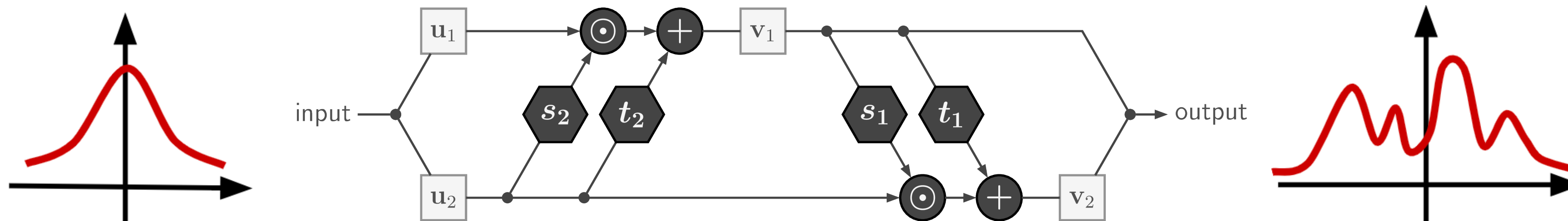

Multi-loop calculations with INN

Profiting from the Jacobian

Precision predictions based on loop diagrams

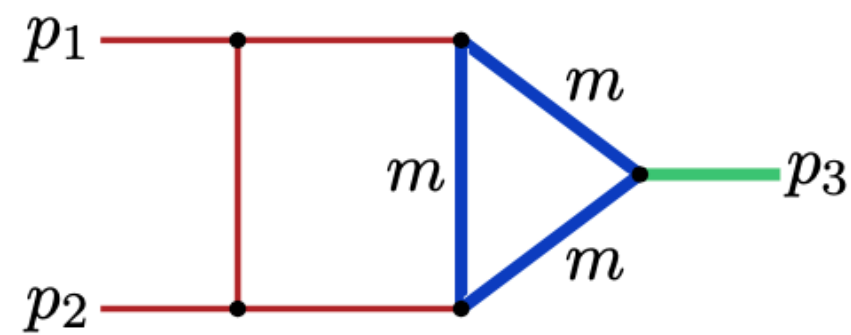

Solved by contour deformation due to Cauchy's theorem

$$\int_0^1 \prod_{j=1}^N dx_j I(\vec{x}) = \int_0^1 \prod_{j=1}^N dx_j \det\left(\frac{\partial \vec{z}(\vec{x})}{\partial \vec{x}}\right) I(\vec{z}(\vec{x}))$$

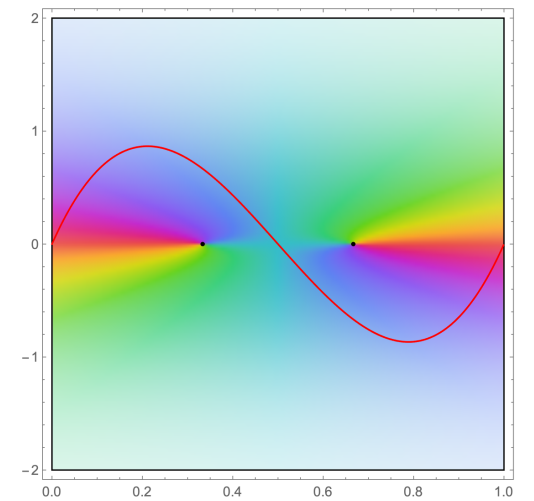

Analytic expression for loop amplitude

$$G = \int_{-\infty}^{\infty} \left(\prod_{l=1}^L \frac{d^D k_l}{i\pi^{D/2}} \right) \prod_{j=1}^N \frac{1}{(q_j^2 - m_j^2 + i\delta)^{\nu_j}}$$

$$= \int_0^1 \prod_{j=1}^{N-1} dx_j x_j^{\nu_j-1} \frac{U^{\nu-(L+1)D/2}}{F^{\nu-LD/2}} = \int_0^1 \prod_{j=1}^{N-1} dx_j I(\vec{x})$$

Rewrite with Feynman parameters

Still contains singularities



Optimal parametrization = minimal variance

Turn it into an ML Problem

Parametrization $\rightarrow z = \text{INN}(x)$

Variance $\rightarrow \mathcal{L}$

